

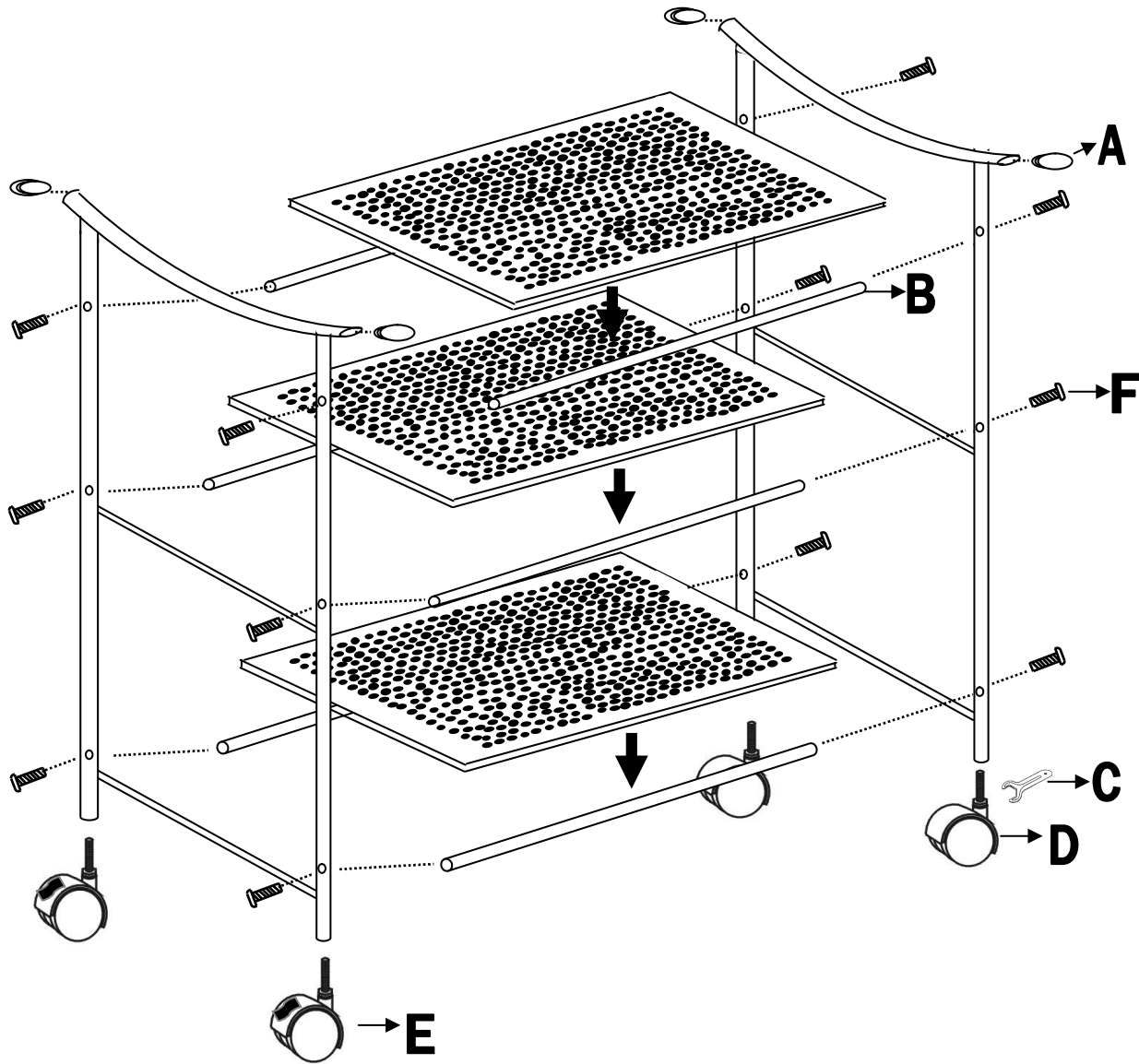





# 83481-10 ACHERON 2



 <b>D x 2</b>	 <b>A x 4</b>
 <b>E x 2</b>	 <b>B x 6</b>
 <b>F x 12</b>	 <b>C x 1</b>

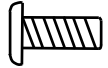