

ROYAL D90N

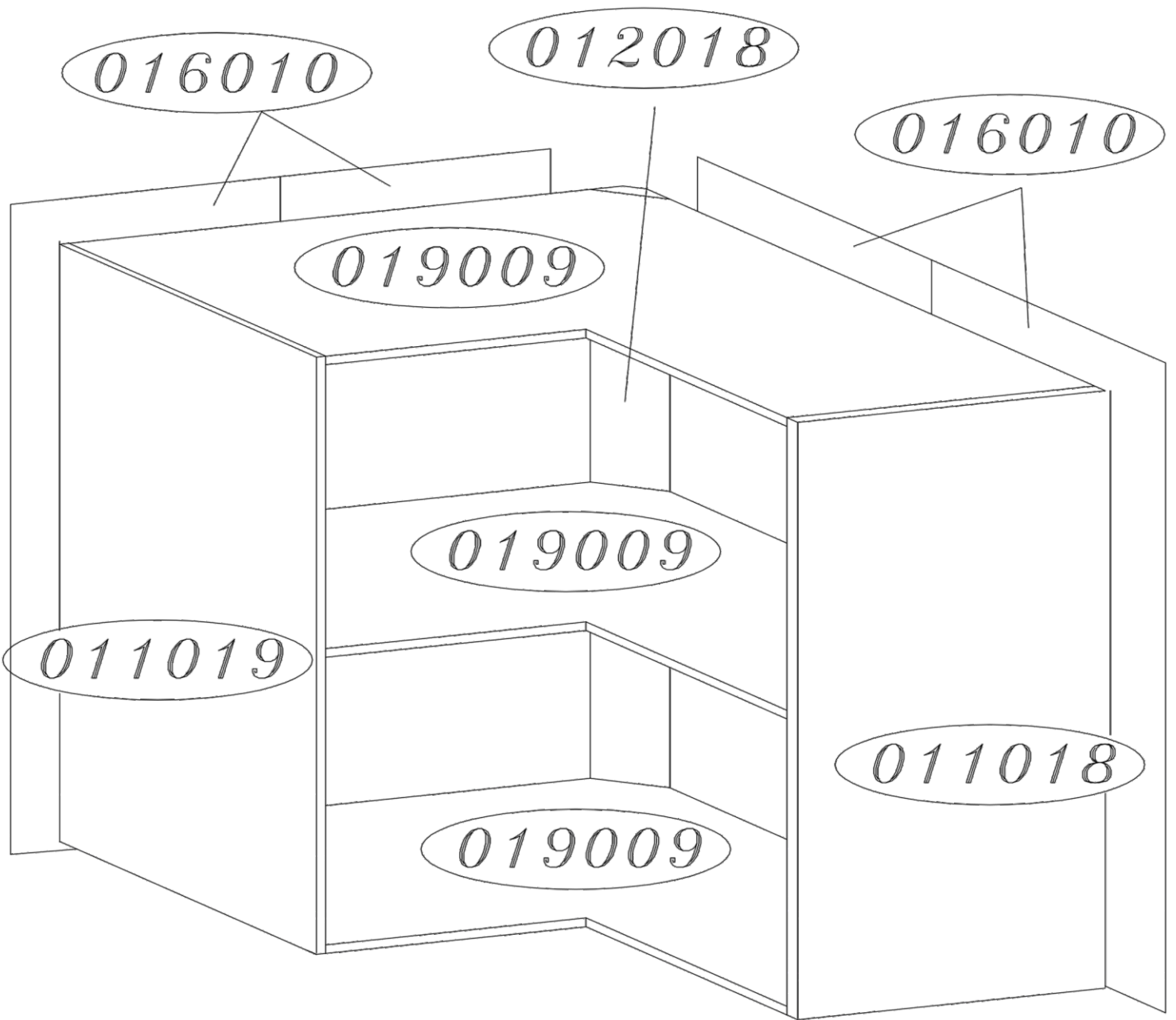

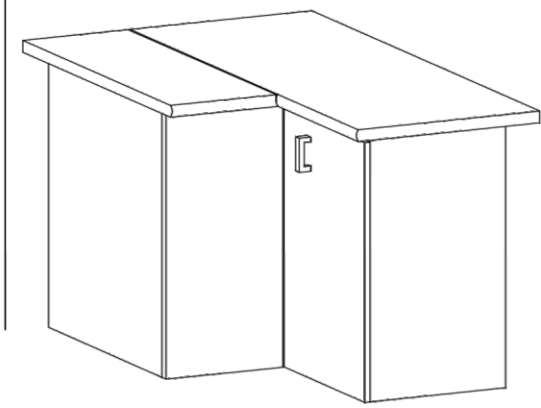

| | | D90N | |
|------------|-------------|--------|--------|
| SYSTEM | KOLOR | L | P |
| SAN MARINO | KREMOWY | 400429 | 400428 |
| COSTA | LAKIER BIEL | 010429 | 010428 |
| MALAGA | DĄB COUNTRY | 390429 | 390428 |

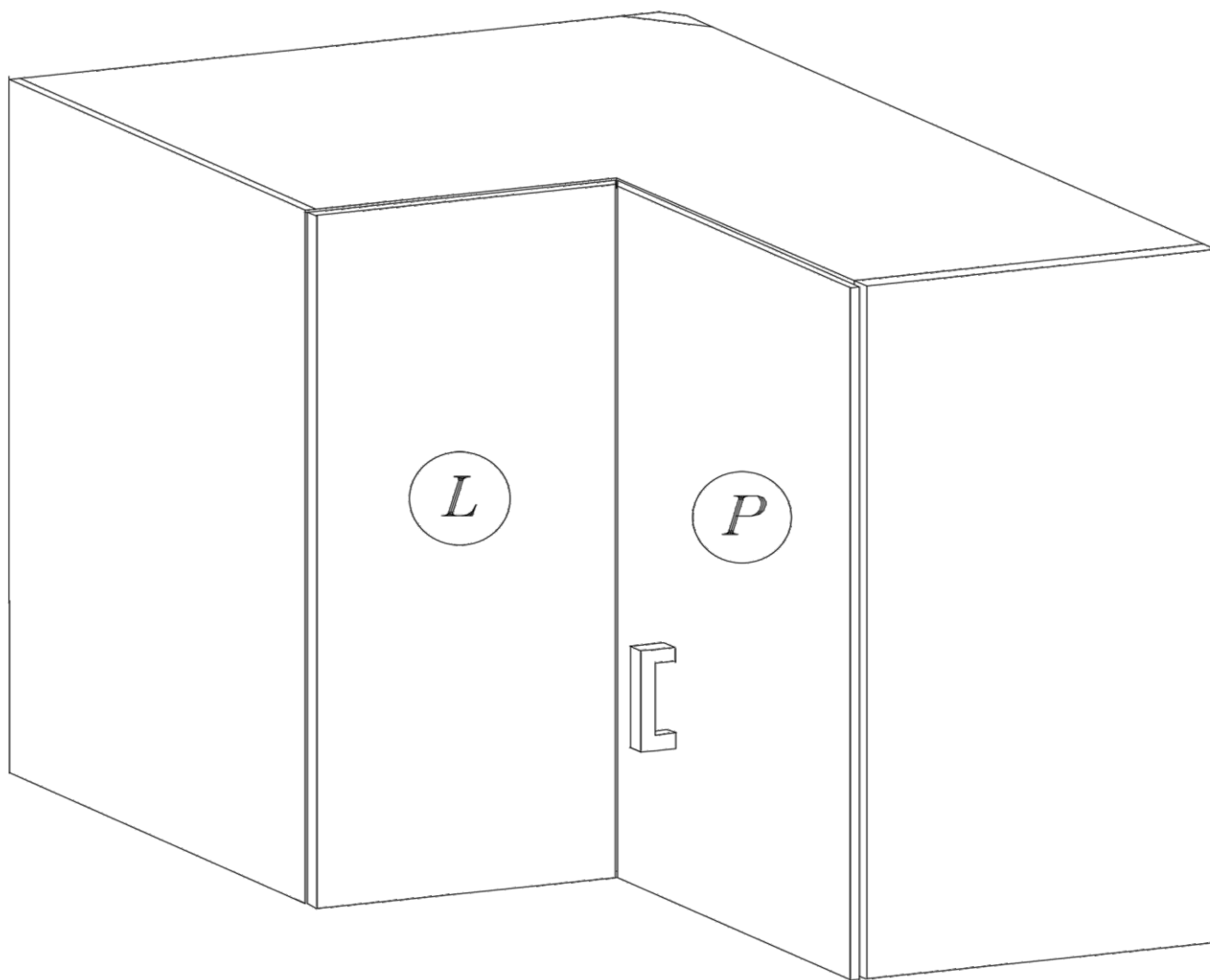
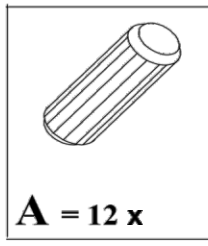

A = 12 x

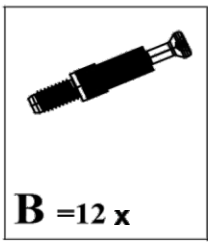

B = 12 x

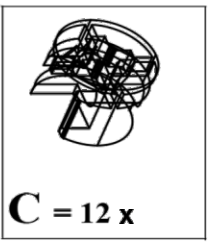

C = 12 x

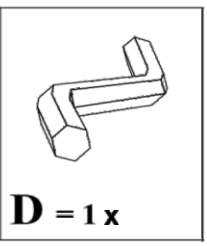

D = 1 x

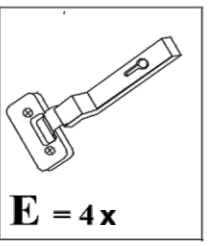

E = 4 x

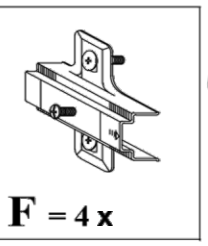

F = 4 x

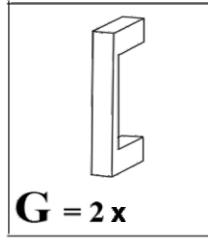

G = 2 x

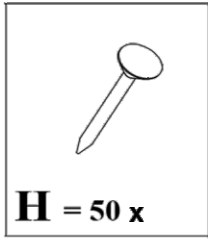

H = 50 x

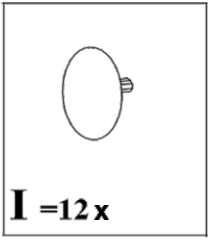

I = 12 x

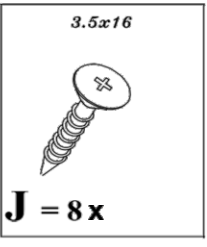

J = 8 x

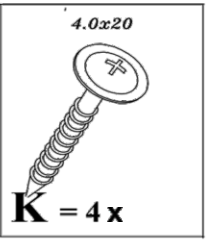

K = 4 x

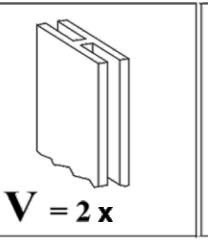

V = 2 x

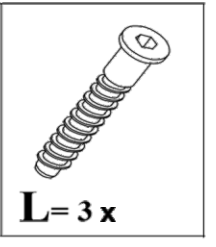

L = 3 x

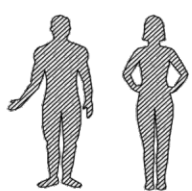
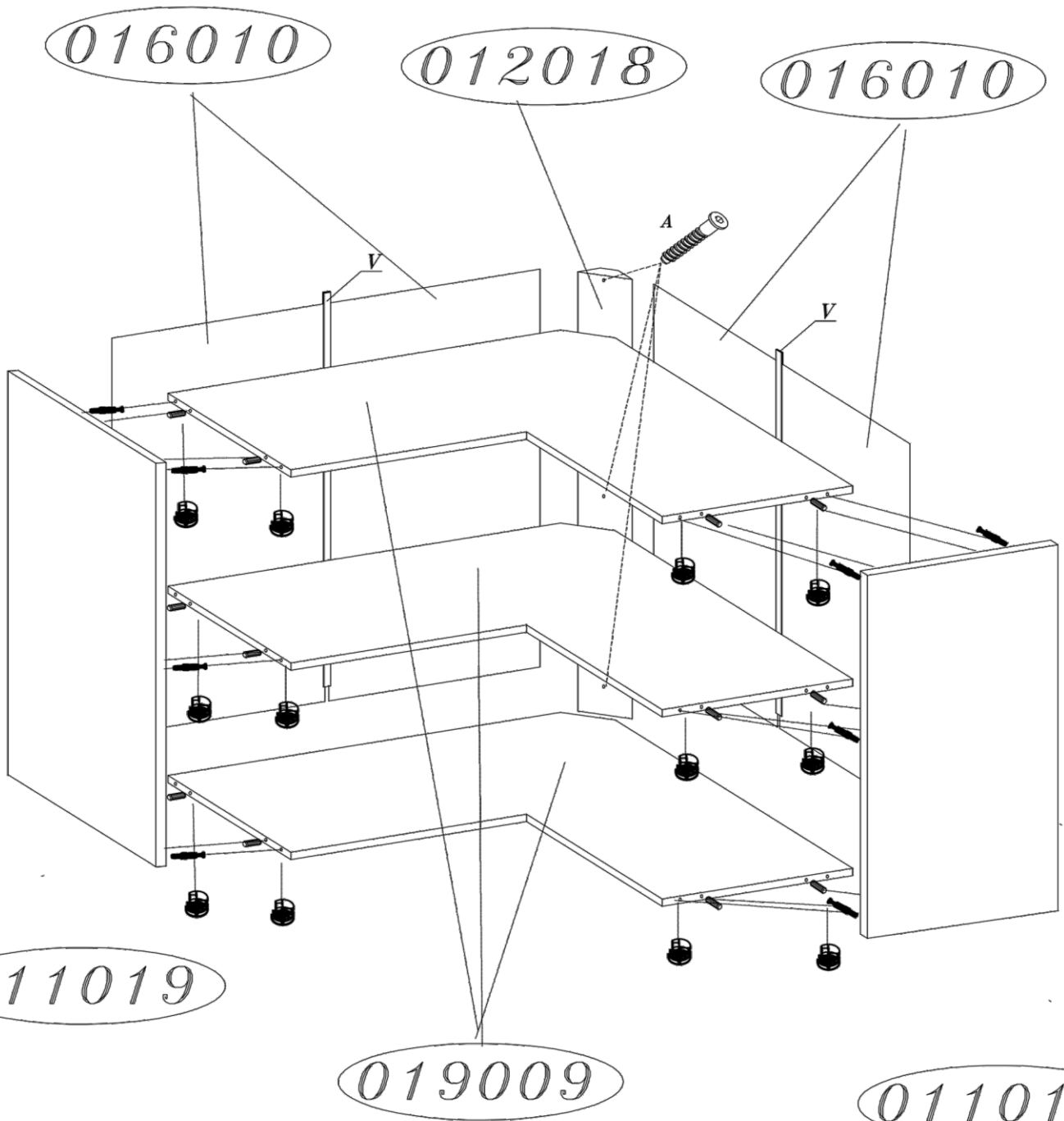

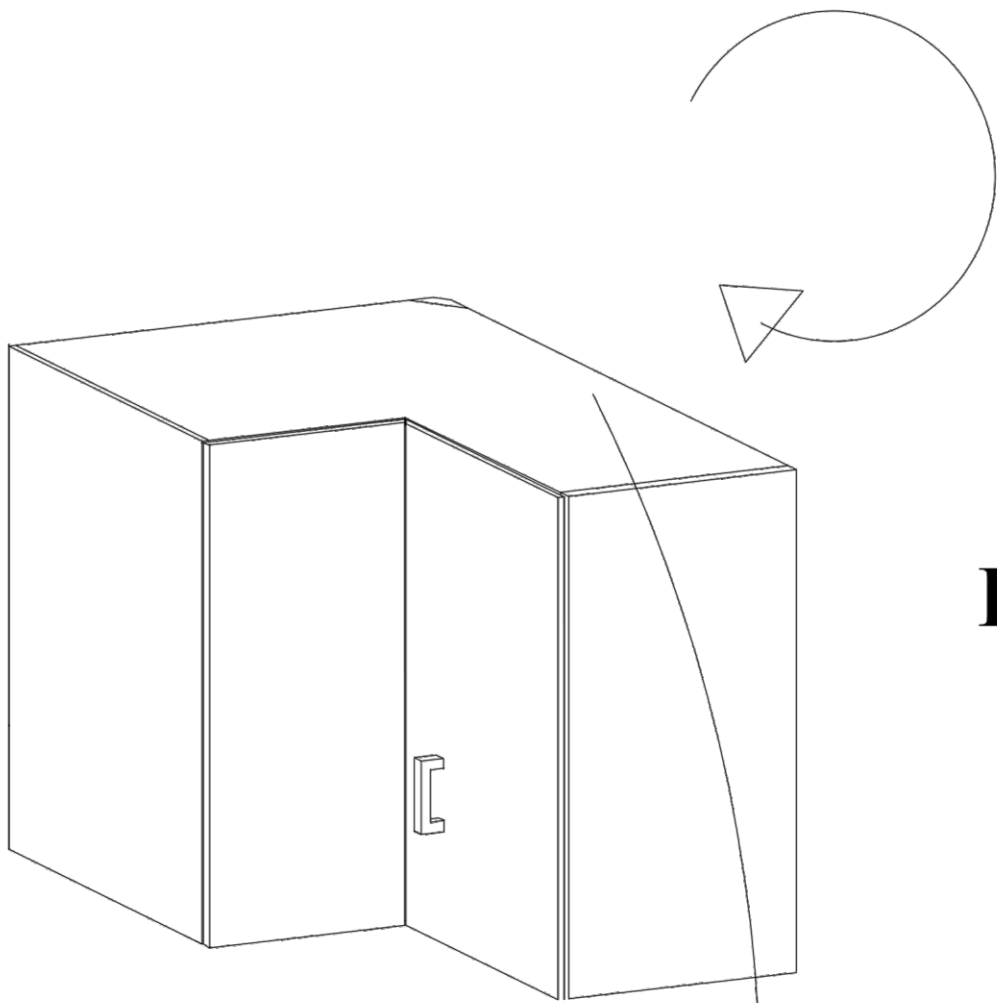

I

