

SK NÁVOD NA MONTÁŽ
 CZ MONTÁŽNÍ NÁVOD
 HU SZERELÉSI UTASÍTÁS
 DE MONTAGEANLEITUNG

ANABELA

	1200	mm
	850	
	280	





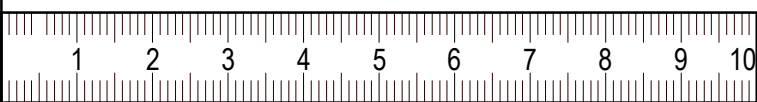
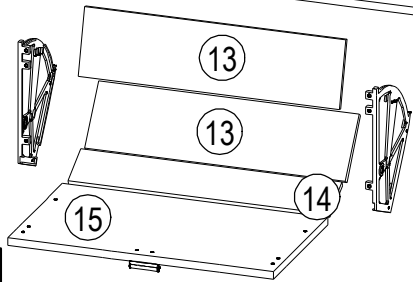
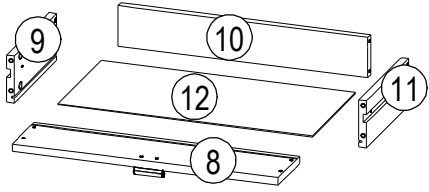
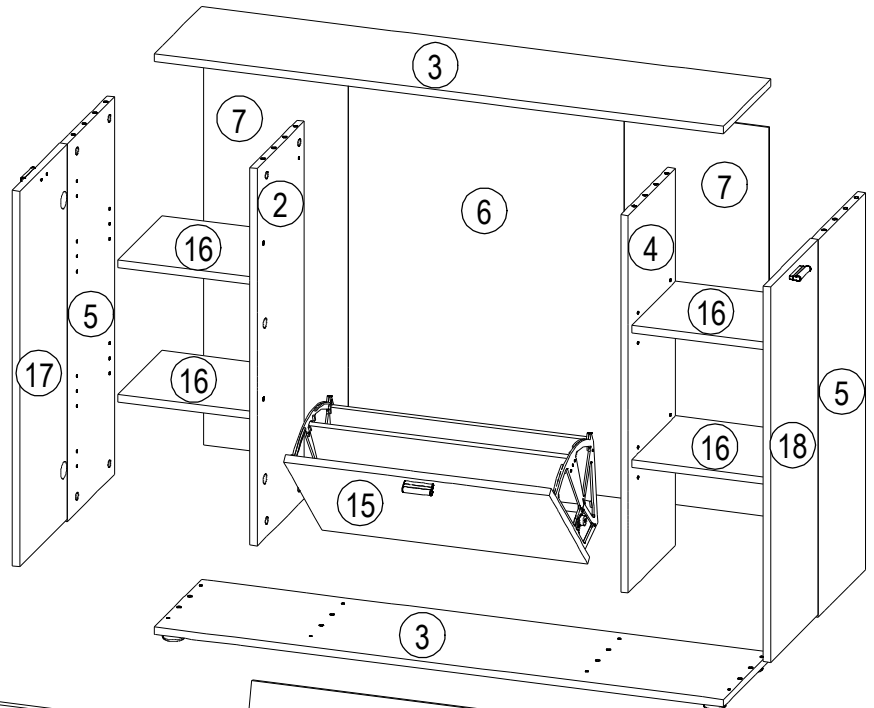



	 100min		 PZ1,PZ2	 4	 ≤ 0,5 kg	 3m	 600 mm	
--	------------	--	-------------	-------	--------------	--------	------------	--

11008	②	802*279*16	1x	1/1
11009	③	1200*280*16	2x	1/1
11010	④	802*279*16	1x	1/1
11011	⑤	802*279*16	2x	1/1
11012	⑥	828*582*2,5	1x	1/1
11013	⑦	828*305*2,5	2x	1/1
11014	⑧	560*128*16	1x	1/1
11015	⑨	250*100*16	1x	1/1
09828	⑩	526*86*16	1x	1/1
11016	⑪	250*100*16	1x	1/1
00969	⑫	256*536*2,5	1x	1/1
09831	⑬	550*140*10	4x	1/1
11017	⑭	550*86*10	2x	1/1
11018	⑮	560*321*16	2x	1/1
11019	⑯	283*261*16	4x	1/1
11026	⑰	798*280*16	1x	1/1
11027	⑱	798*280*16	1x	1/1







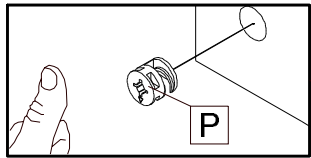
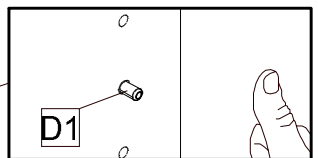
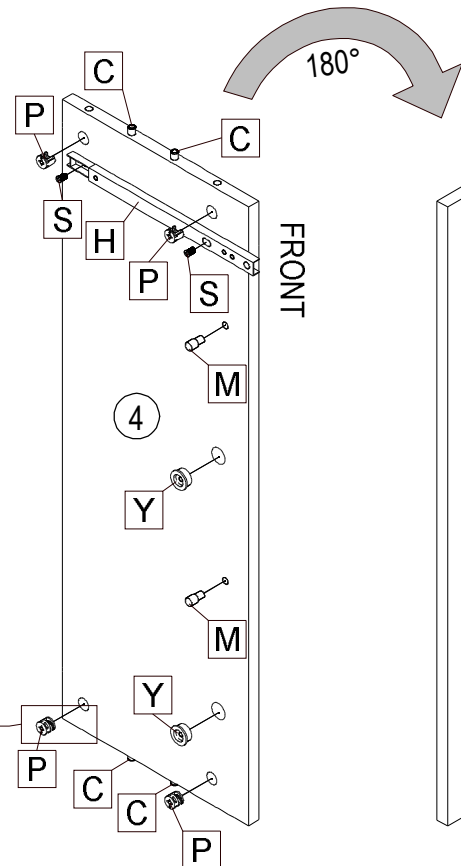
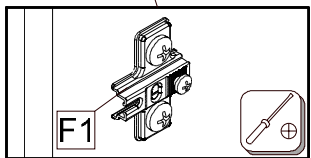
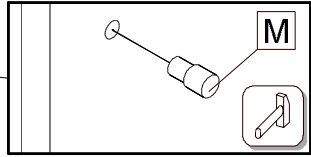
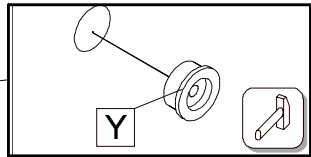
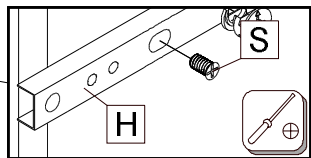
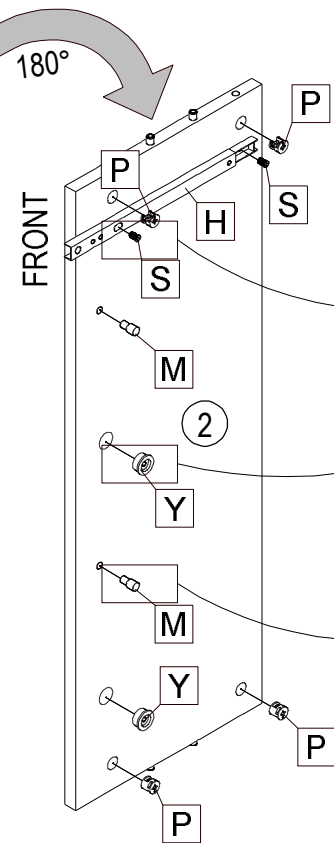
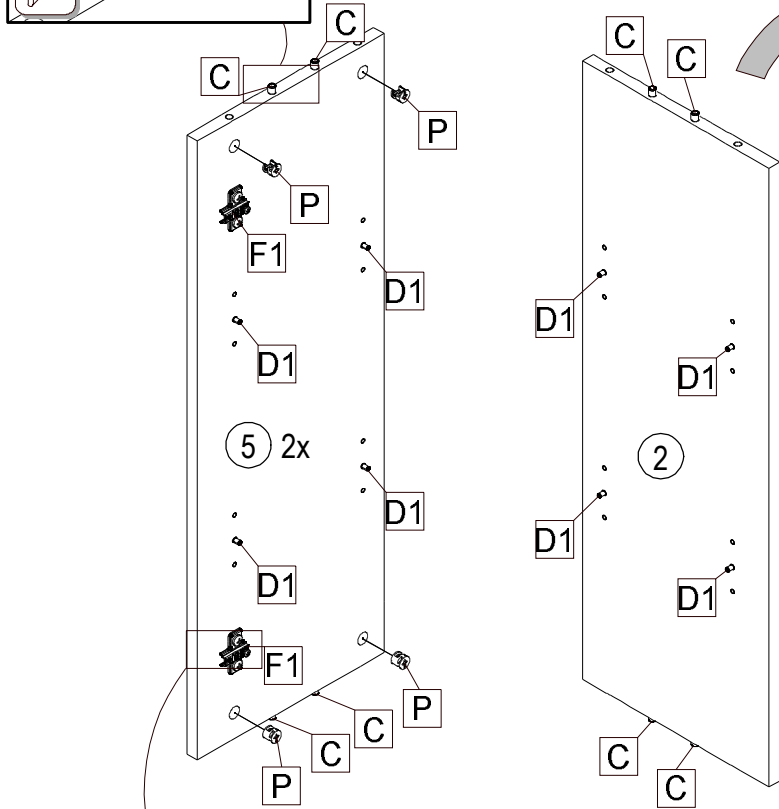
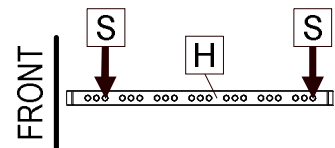
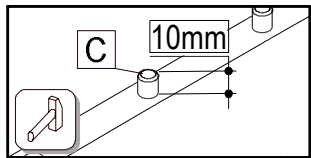

22300,00 Ø7x50	22502,00 M4x12	27000,00 Ø8x30	32008,00 	22243,00 Ø3,5x15	22213,00 Ø4x70	30080,00 	33030,00 	21102,00 Ø1,2x20	22708,00 Ø6x16
A 4x	B 2x	C 16x	D 5x	E 8x	F 1x	G 6x	H 1x	J 50x	K 16x
31103,00 	24114,00 		70013,01 	70021,01 	22501,02 M4x20	22705,00 Ø6,3x8	22244,01 Ø3,5x16	24103,00 Ø8	50553,00
L 1x	M 4x	N 12x	P 20x	Q 20x	R 10x	S 4x	T 7x	U 1x	V 2x
24113,00 	31134,00 	24115,00 	31135,00 	22236,00 Ø2,5x16	22250,00 Ø4x25	24008,00 	35101,01 	36001,01 	36001,01
W 4x	X 2x	Y 4x	Z 2x	A1 28x	B1 6x	C1 16x	D1 16x	E1 4x	F1 4x





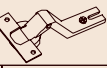

							
C 16x	H 1x	M 4x	P 16x	S 4x	D1 16x	F1 4x	Y 4x

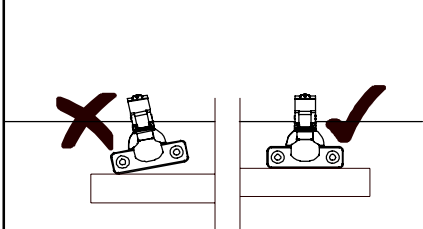
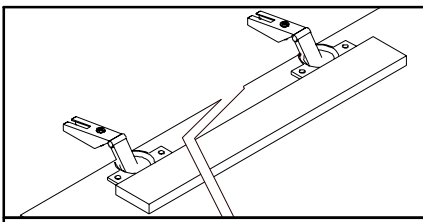
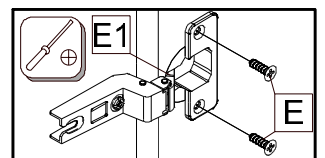
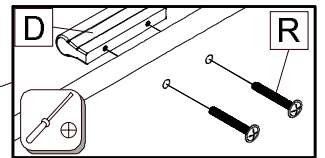
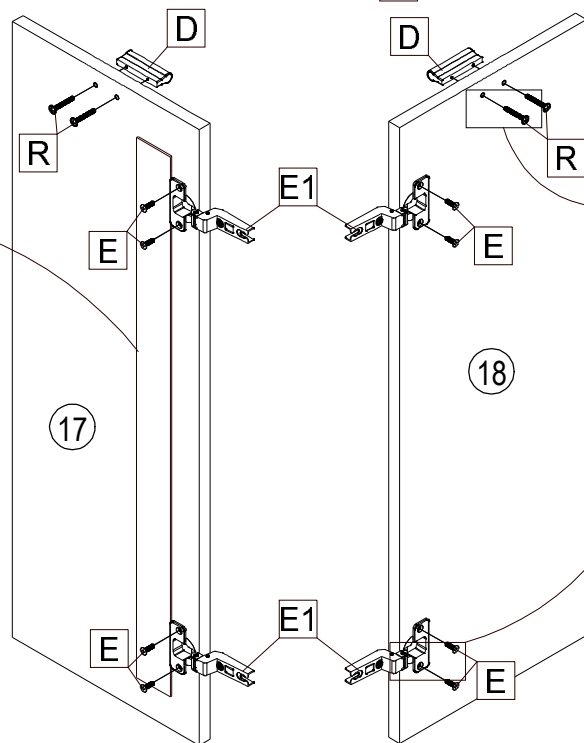
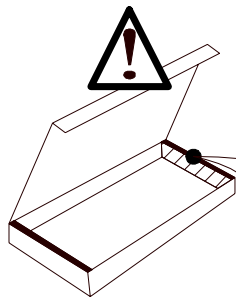
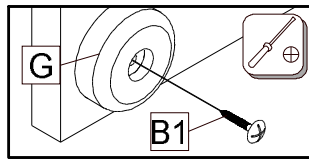
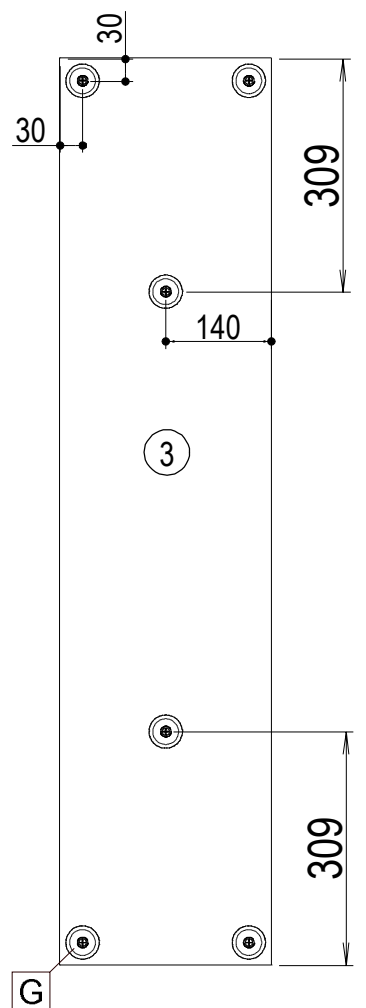
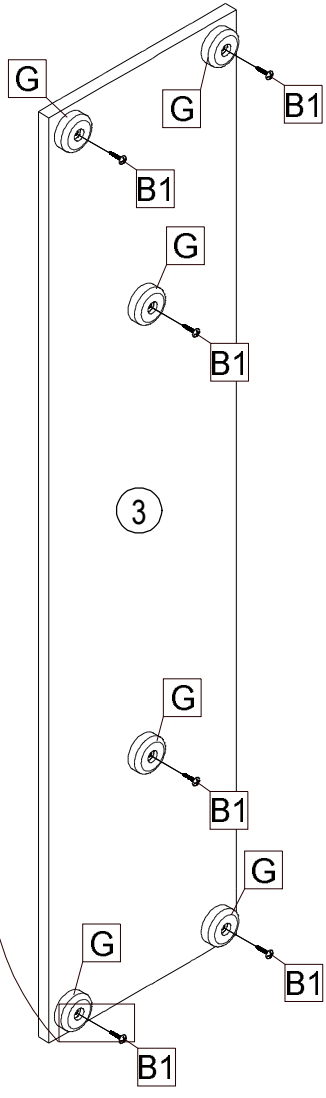
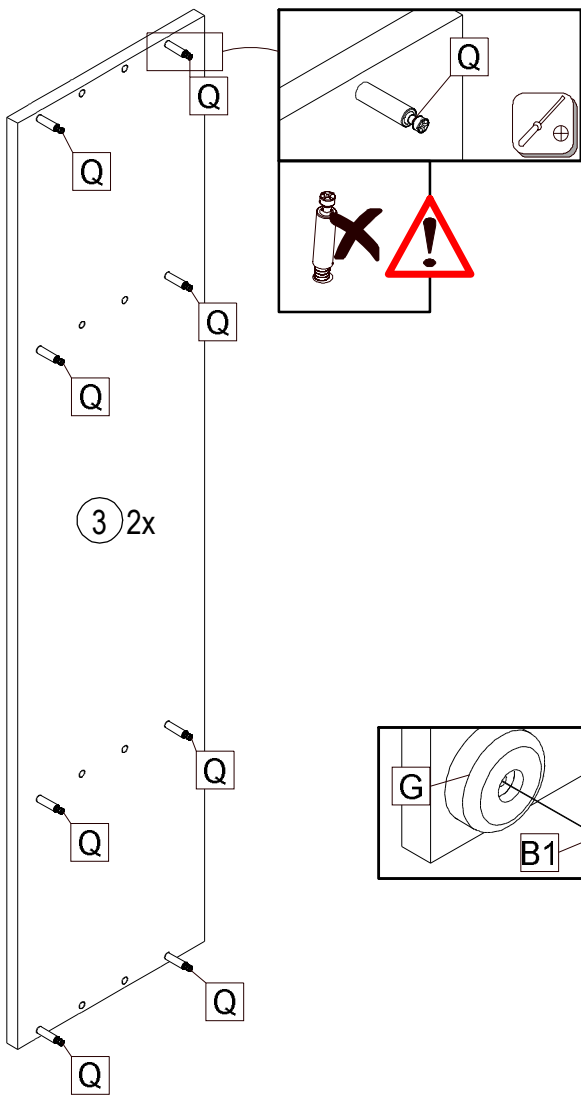



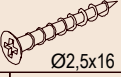

						
D 2x	E 8x	G 6x	Q 16x	R 4x	B1 6x	E1 4x

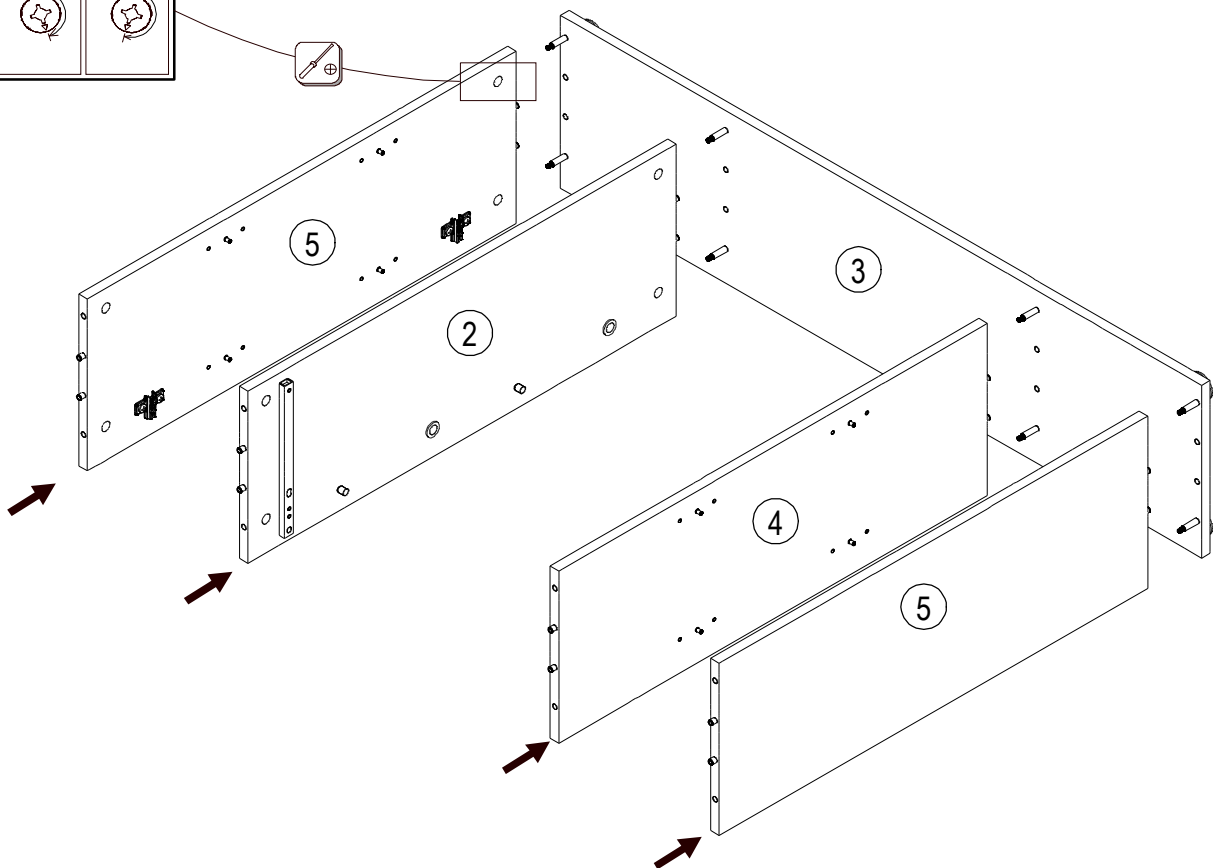
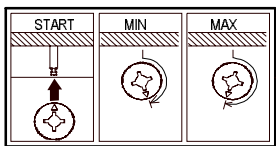
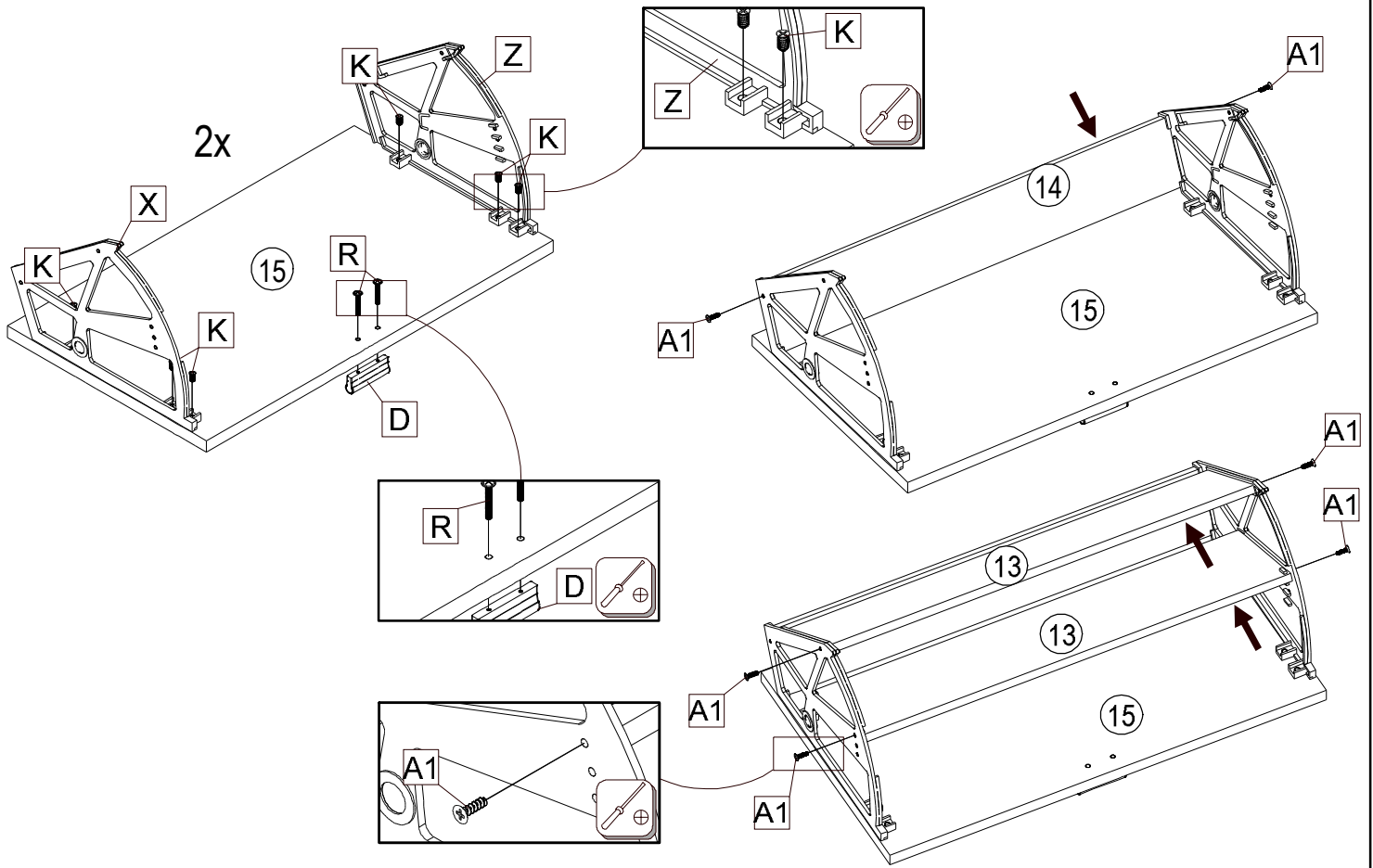

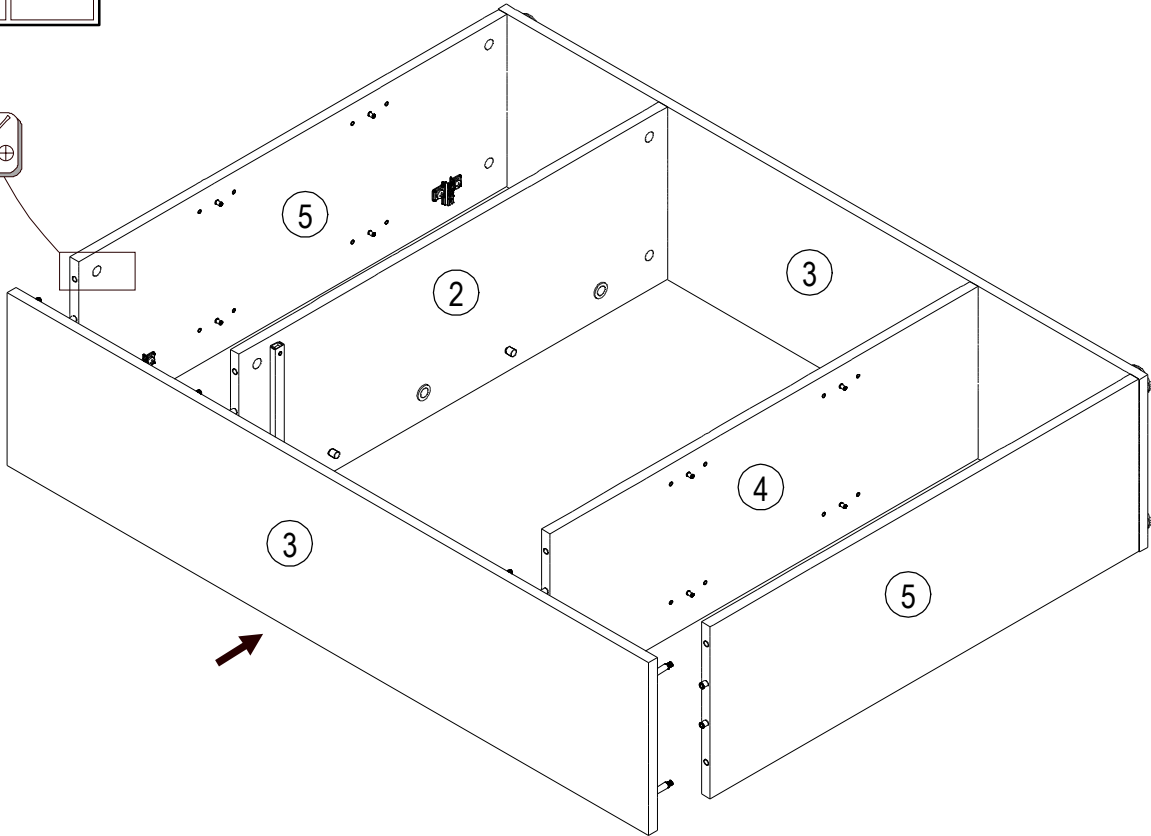
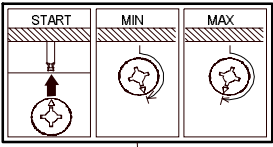

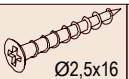

					
D 2x	K 12x	R 4x	X 2x	Z 2x	A1 12x



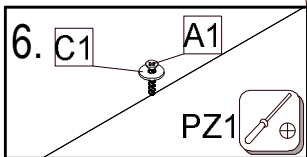
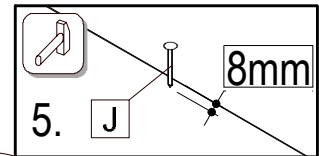
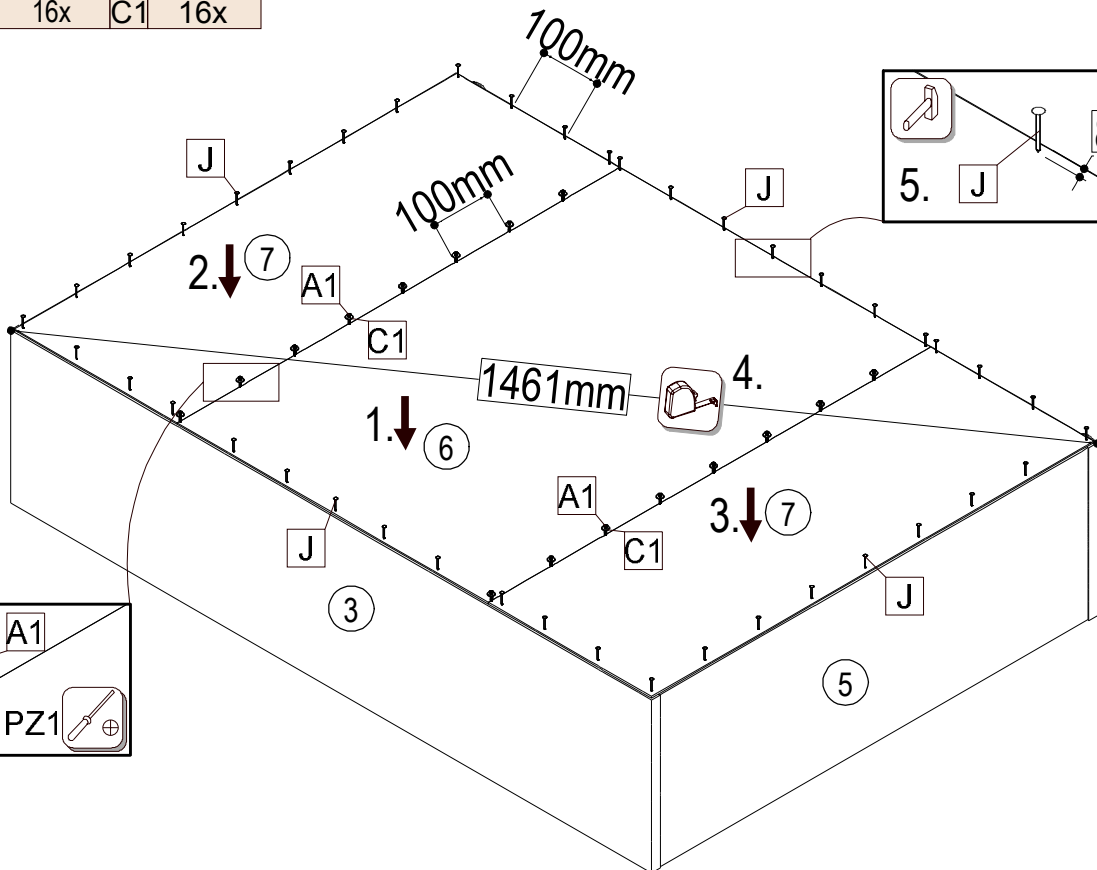



		
∅1,2x20	∅2,5x16	
J 50x	A1 16x	C1 16x



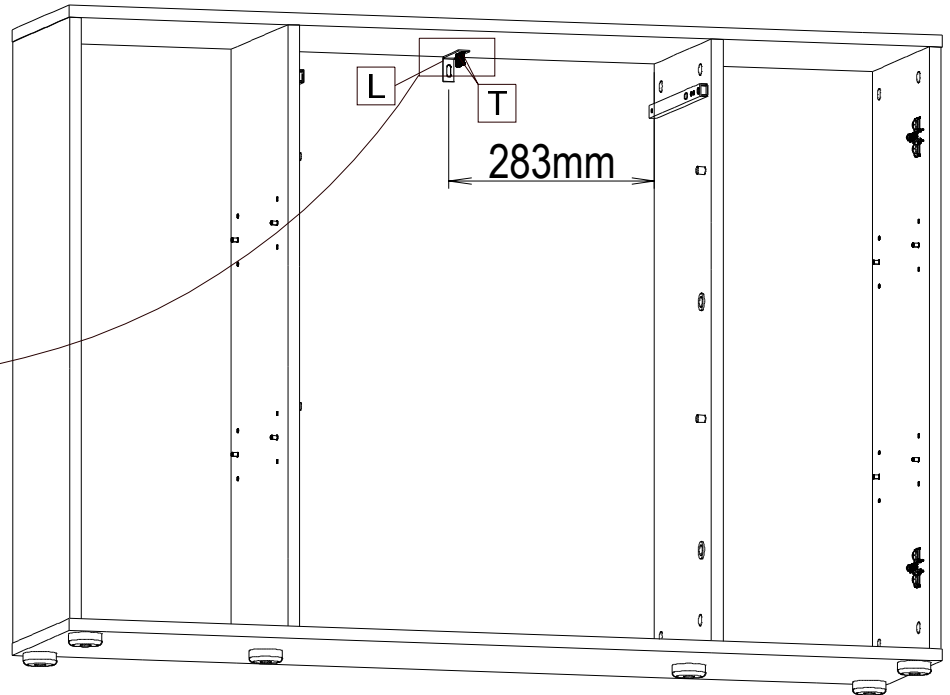
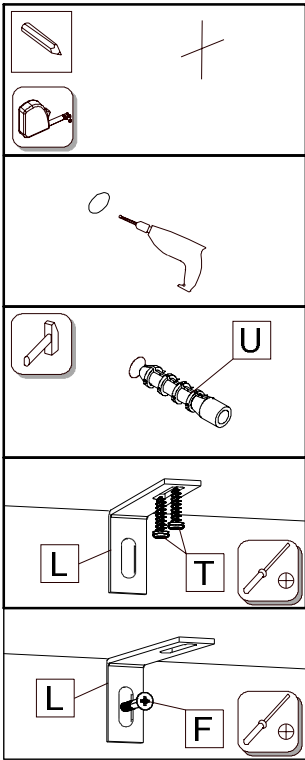
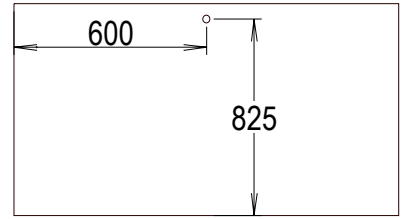



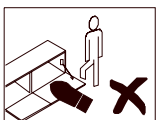
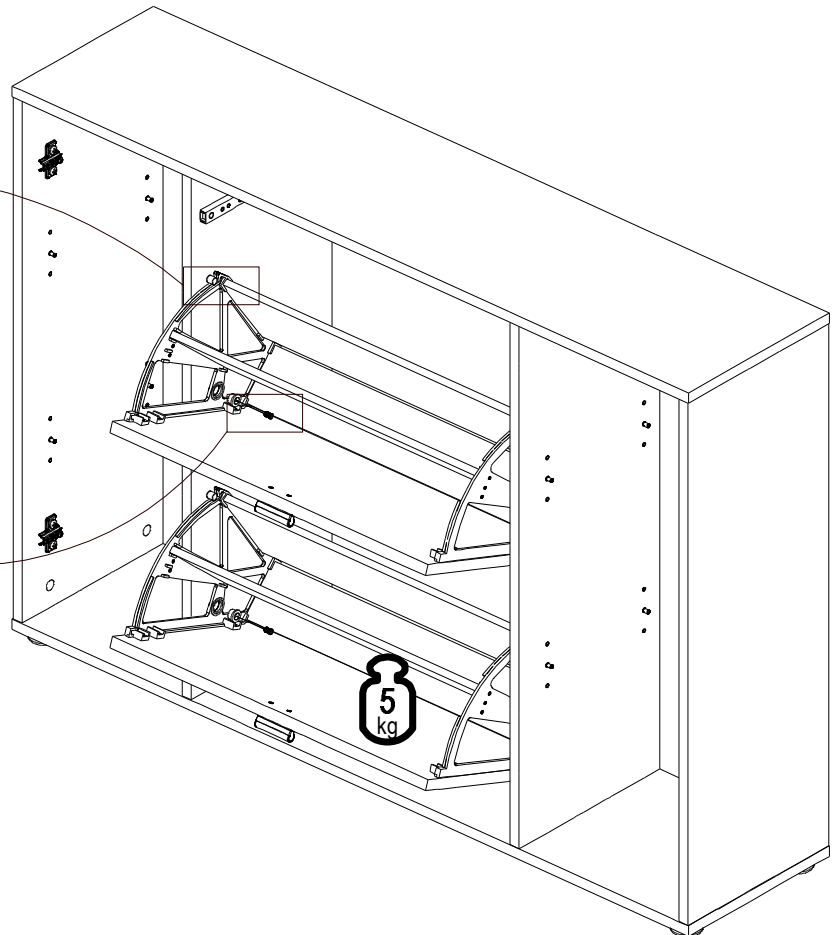
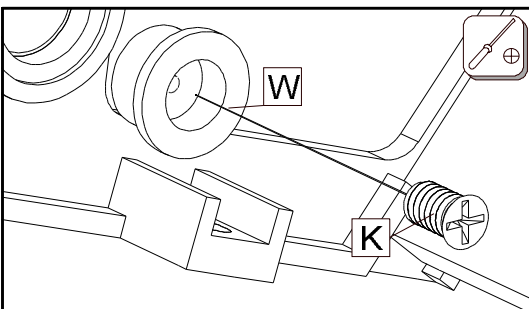
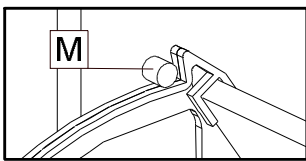

			
Ø4x70		Ø3,5x16	Ø8
F 1x	L 1x	T 2x	U 1x



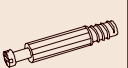

	
Ø6x16	
K 4x	W 4x

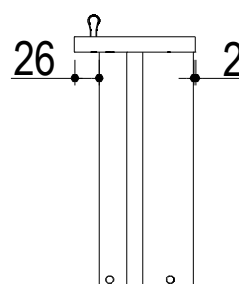
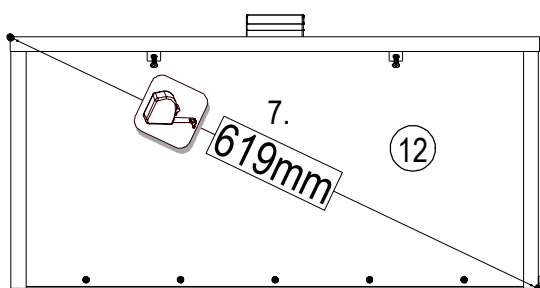
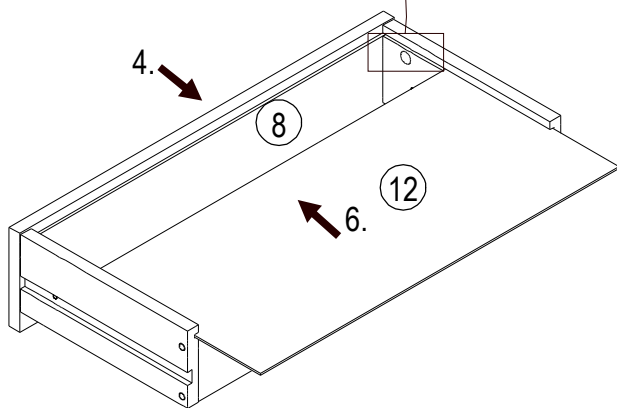
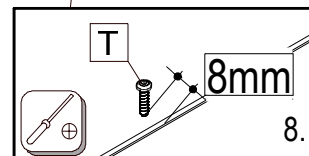
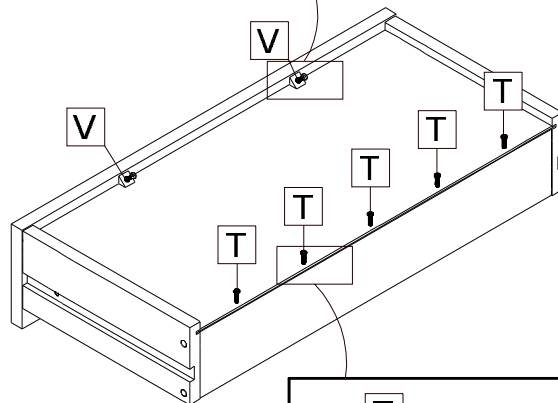
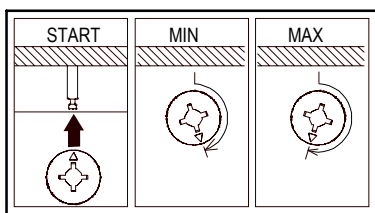
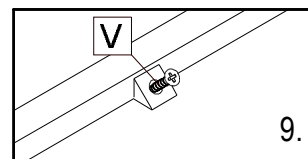
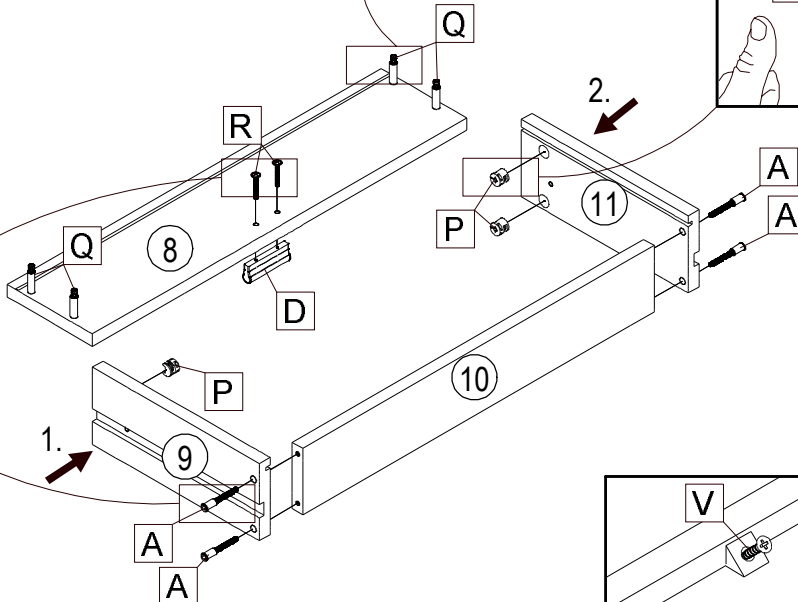
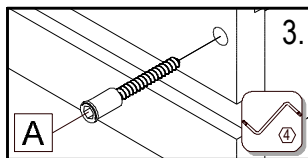
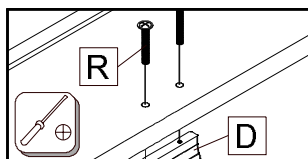
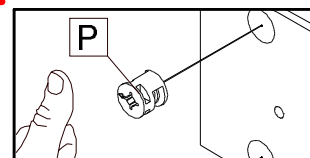
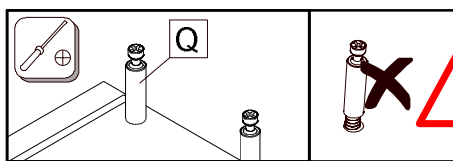
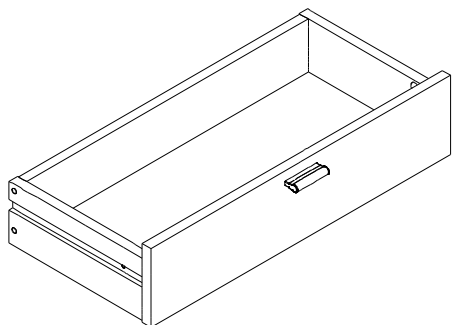

													
A	4x	D	1x	P	4x	Q	4x	R	2x	T	5x	V	2x



	M4x12		
B	2x	N	12x

