

SICILIA D60ZK

016006

011012

019006

011013

019006

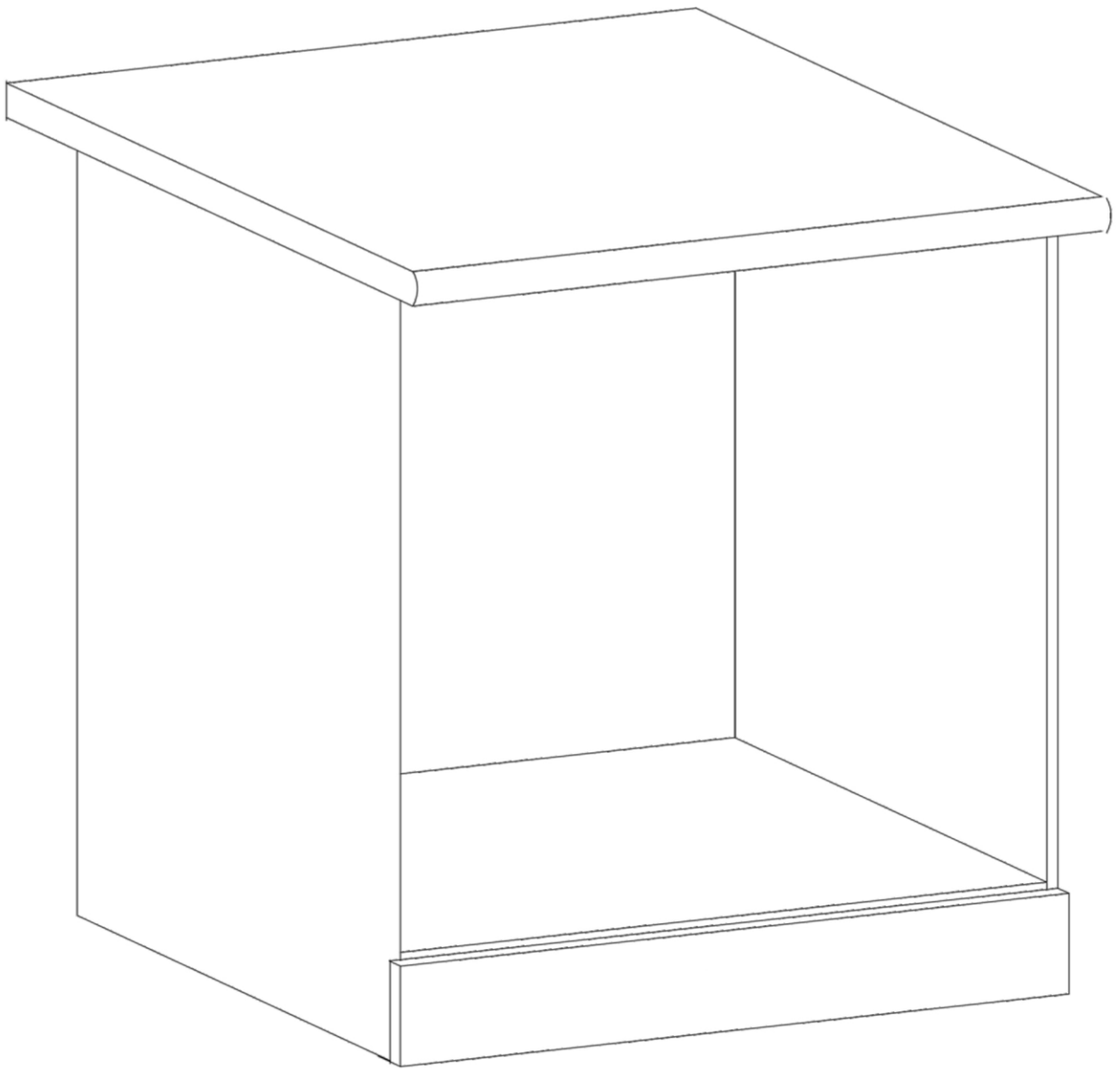

		D60ZK
SYSTEM		
SAN MARINO	KREMOWY	400418
COSTA	LAKIER BIEL	010418
MALAGA	DĄB COUNTRY	390418

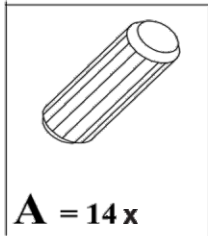

A = 14x

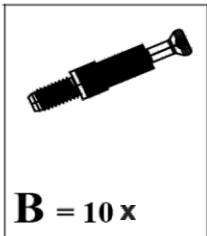

B = 10x

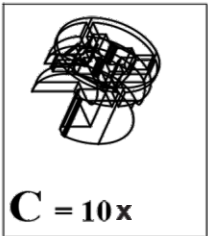

C = 10x

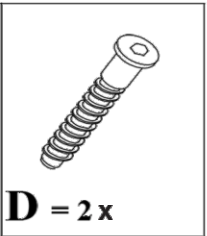

D = 2x

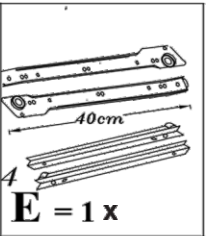

E = 1x

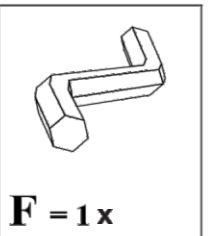

F = 1x

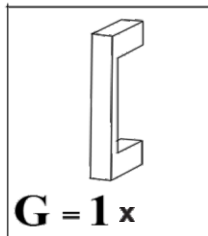

G = 1x

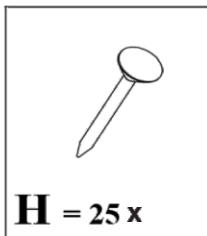

H = 25x

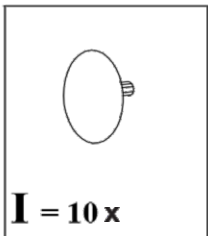

I = 10x

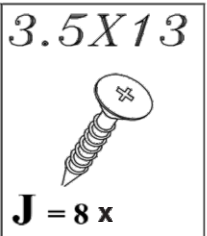

J = 8x

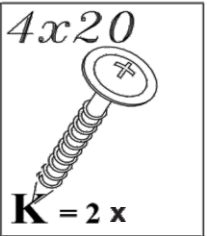

K = 2x

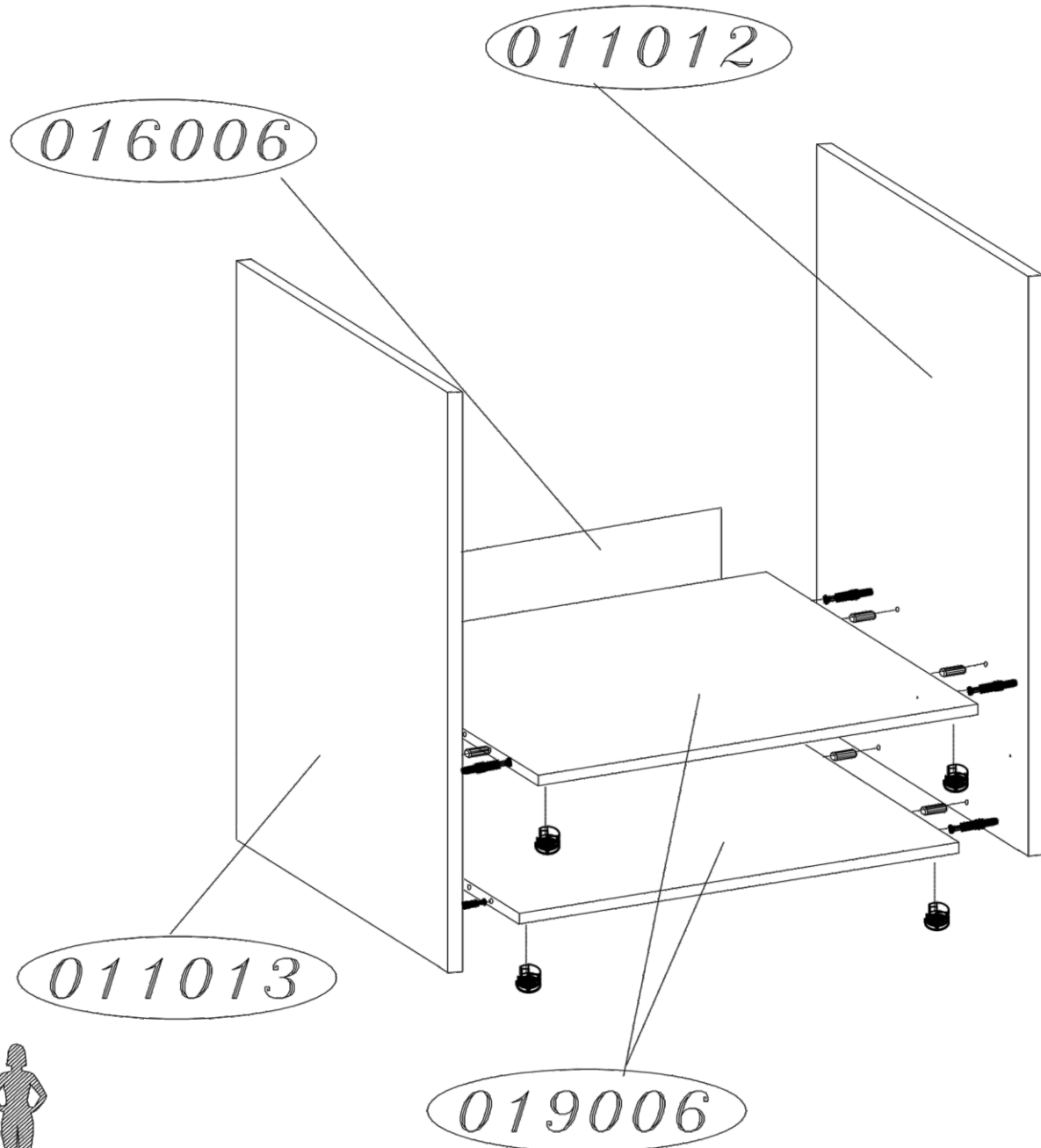

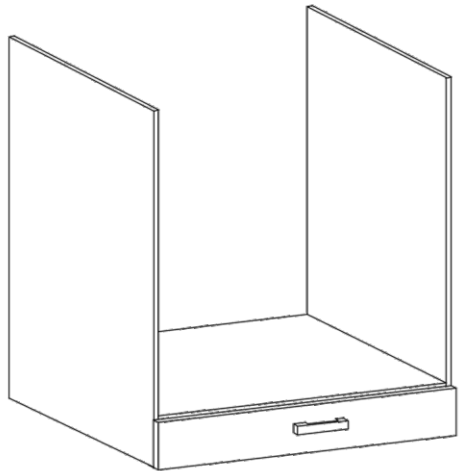

I

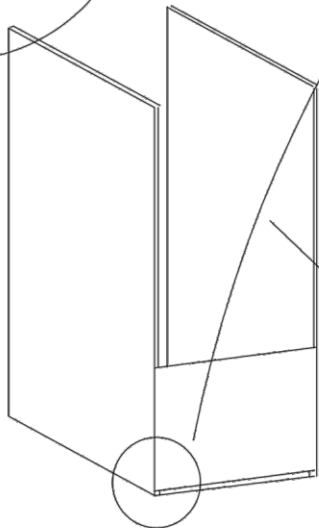
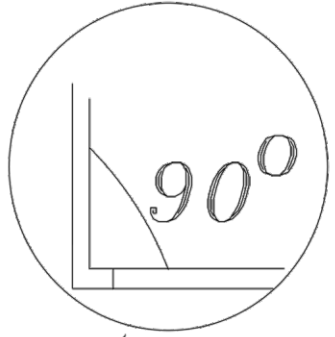
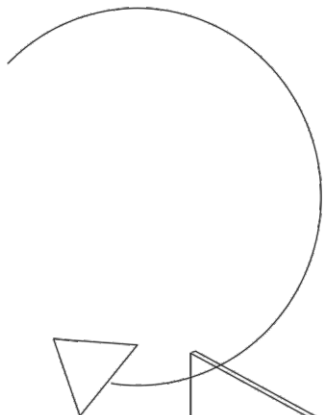

016006

II

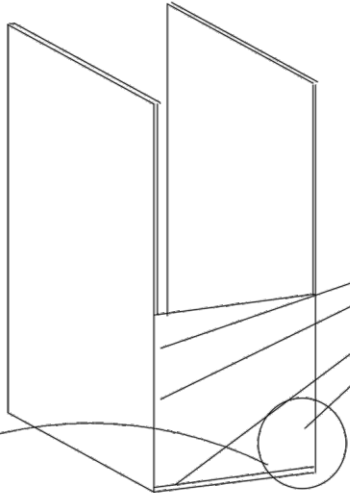

H

