

MARIO NEW B+C-2+8

Art.-Nr.

200310

302
2015
306
mm

1/6
Z0

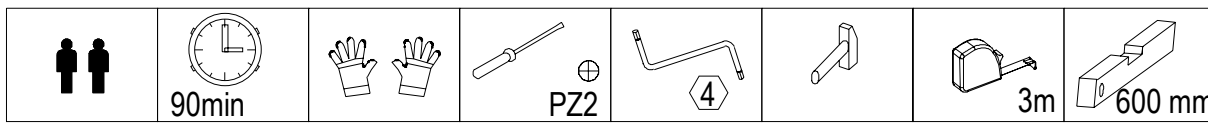



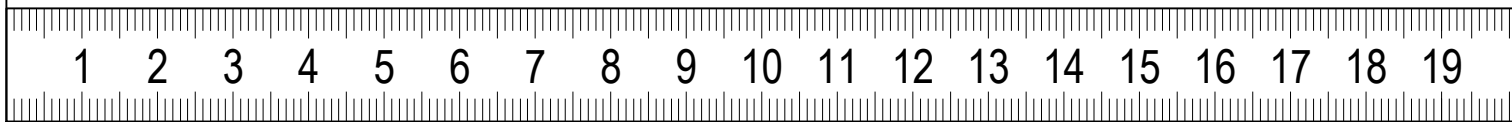
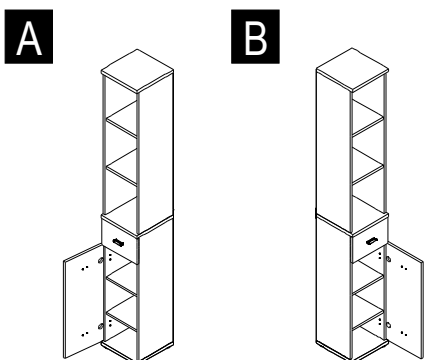
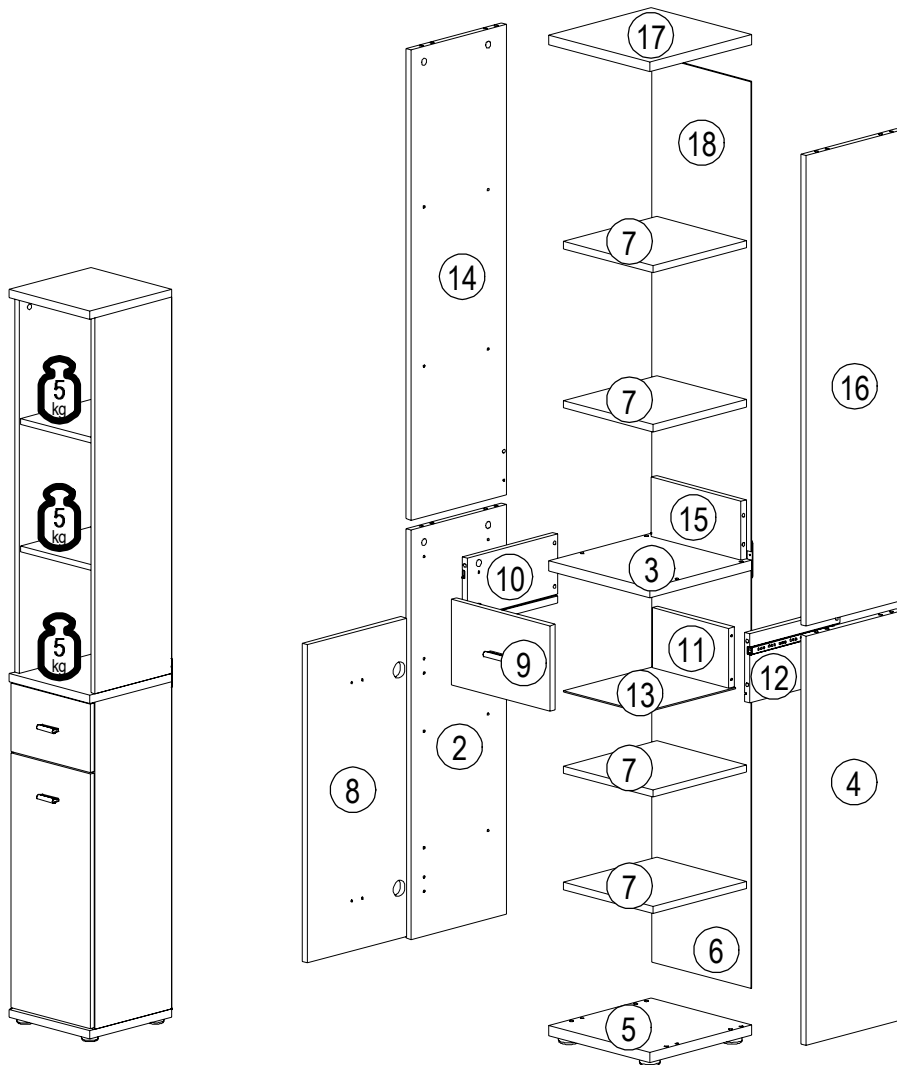

ID	ID	Image	Dimensions	Quantity	Ratio
14024	2	900*286*16	1x	1/1	
14025	3	302*306*22	1x	1/1	
14026	4	900*286*16	1x	1/1	
14027	5	302*306*22	1x	1/1	
14028	6	940*297*2,5	1x	1/1	
14030	7	268*280*16	4x	1/1	
14031	8	700*296*16	1x	1/1	
14032	9	296*188*16	1x	1/1	
14012	10	152*270*16	1x	1/1	
14034	11	132*230*16	1x	1/1	
14014	12	152*270*16	1x	1/1	
14036	13	276*240*2,5	1x	1/1	
14037	14	1034*286*16	1x	1/1	
14038	15	268*130*16	1x	1/1	
14039	16	1034*286*16	1x	1/1	
14040	17	302*306*22	1x	1/1	
14029	18	1034*297*2,5	1x	1/1	

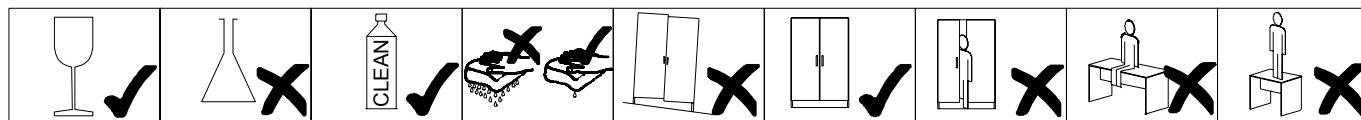

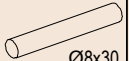

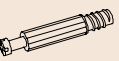

34906.00	35009.00	21102.00	22213.00	22243.00	22244.01	22250.00	22300.00	22430.00
A 14x	B 2x	C 50x	D 1x	E 12x	F 6x	G 4x	H 8x	J 4x
22502.00	22705.00	24103.00	27000.00	31103.00	35101.01	70013.01	70021.01	9290.00
K 2x	L 4x	M 1x	N 18x	P 1x	Q 16x	R 14x	S 14x	T 2x
36002.07	36002.07	30080.00	32008.00	33030.00				
U 2x	V 2x	W 4x	X 2x	Y 1x				

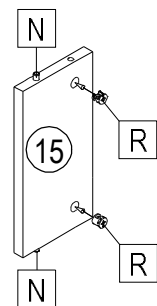
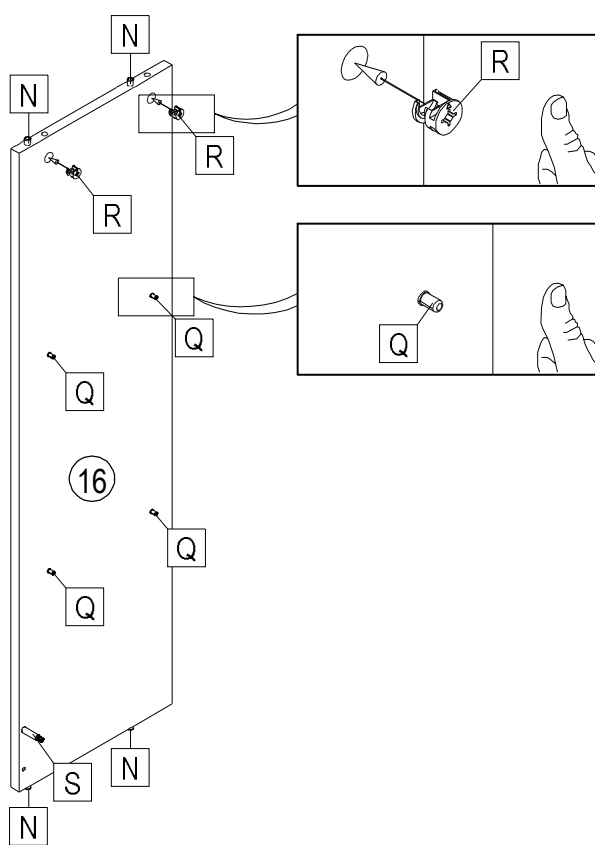
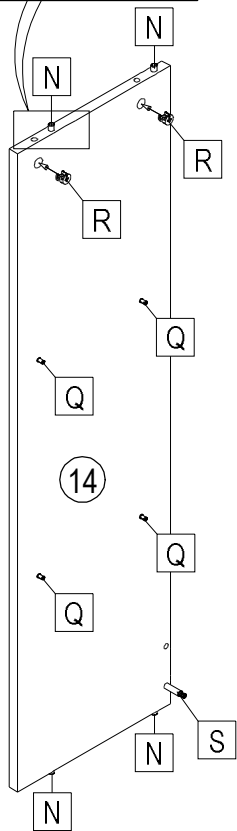
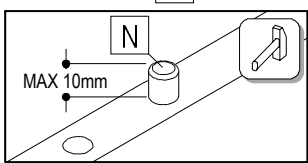
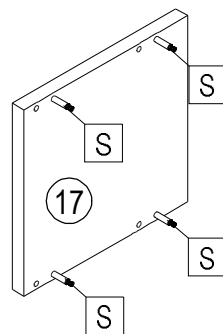
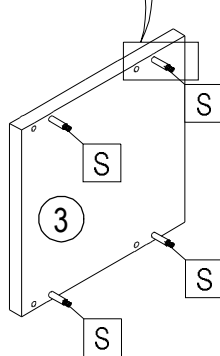
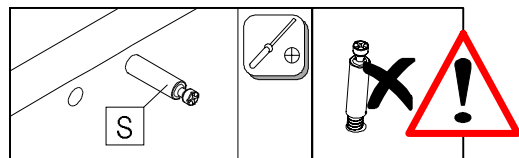
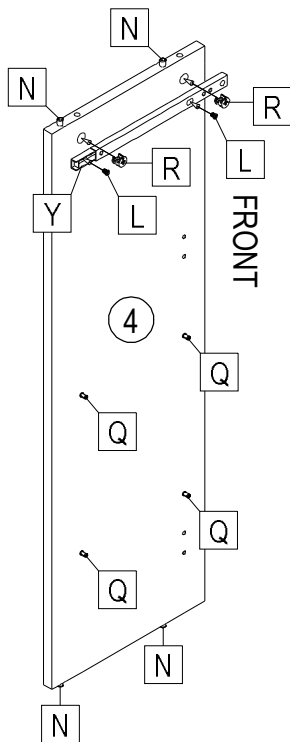
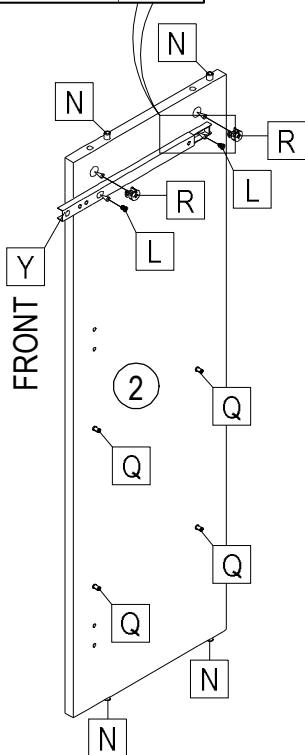
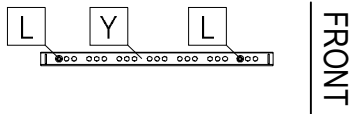
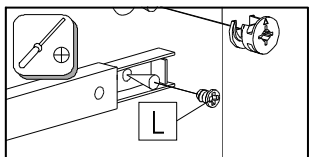

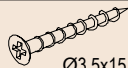

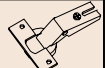

					
Ø6.3x8	Ø8x30		Ø15x13		L=246
L 4x	N 18x	Q 16x	R 10x	S 10x	Y 1x

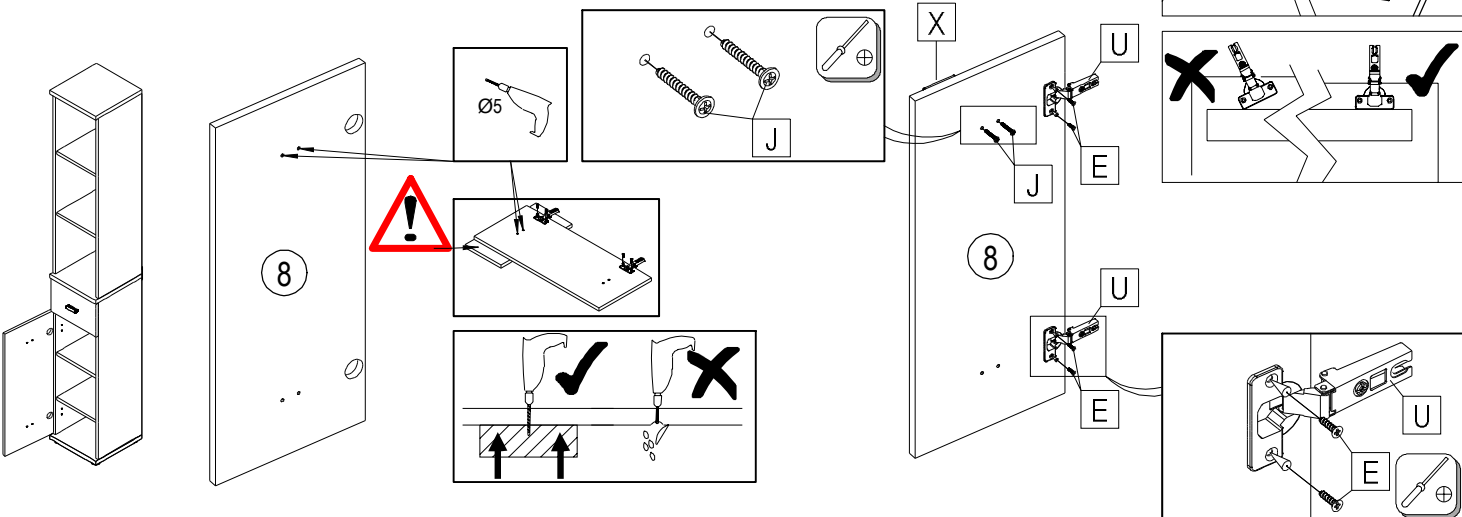

			
Ø3,5x15	Ø4x25		R=32
E 4x	J 2x	U 2x	X 1x

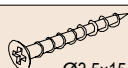
A

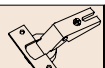

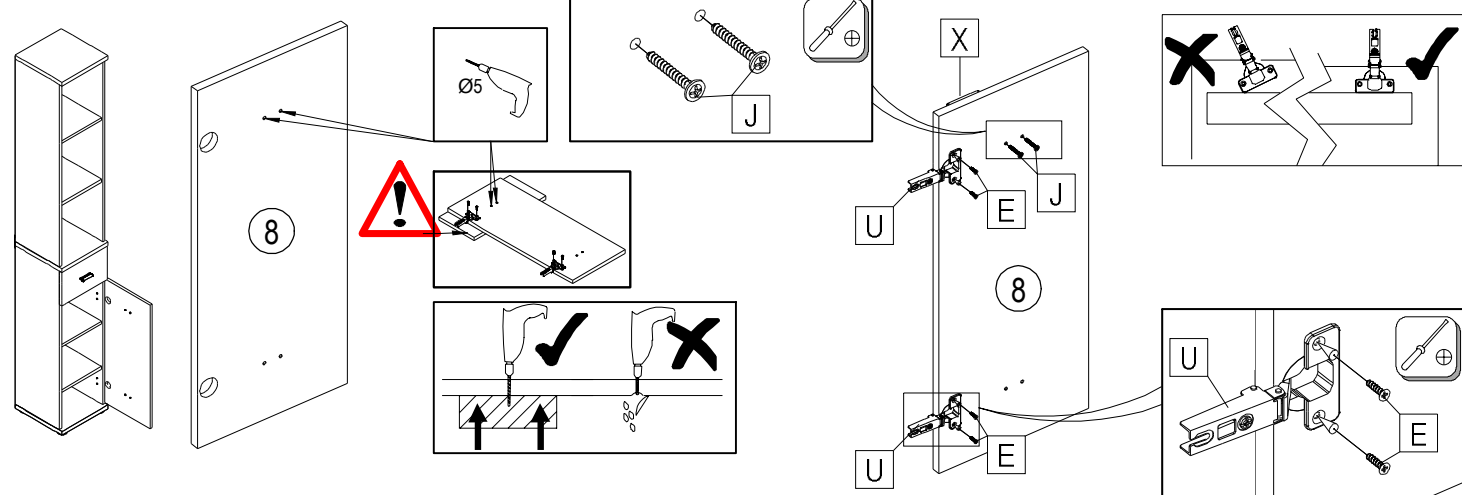

			
Ø3,5x15	Ø4x25		R=32
E 4x	J 2x	U 2x	X 1x

B

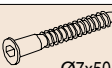

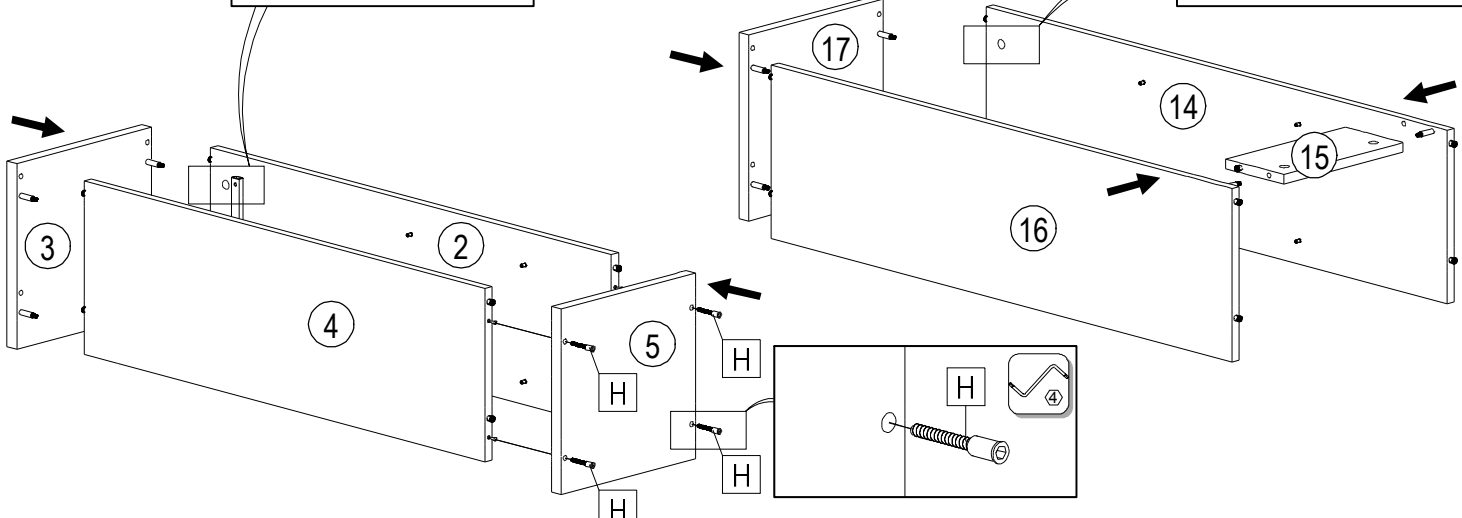

Ø7x50
H 4x

START	MIN	MAX
		

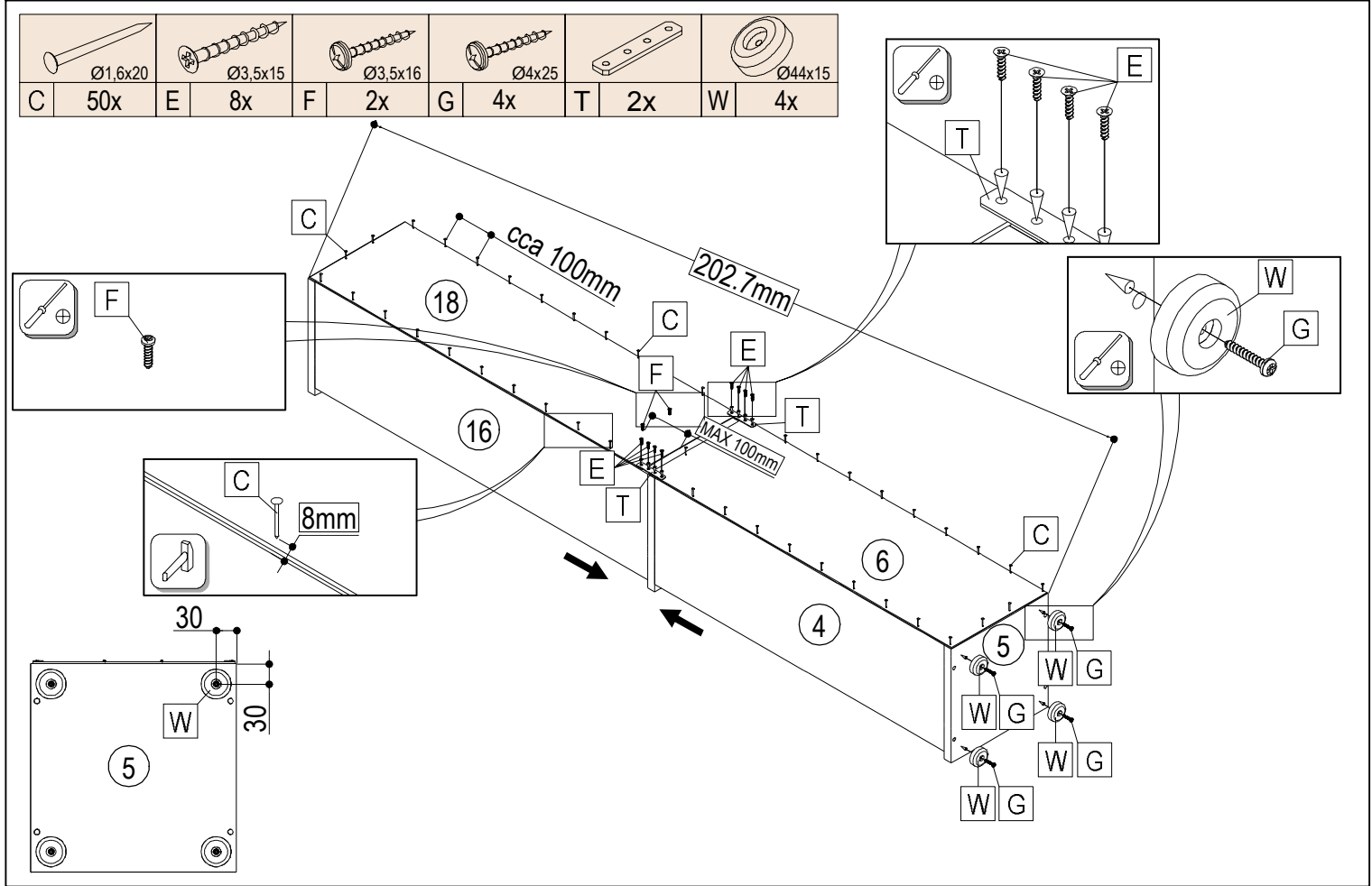

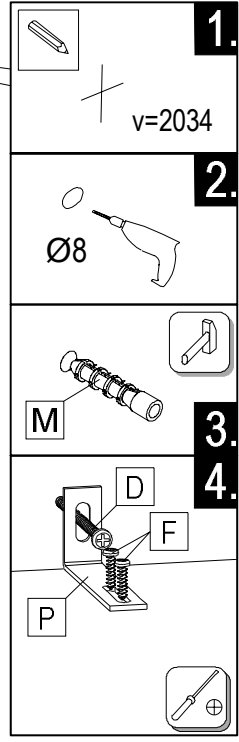
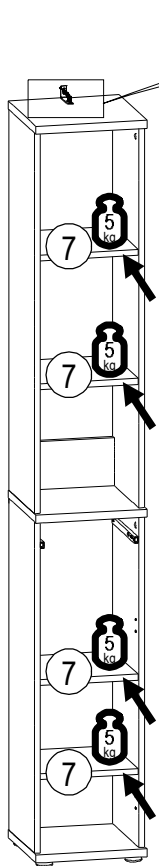

D 1x	F 2x	M 1x	P 1x









Upozornenie! Pevnosť steny sa musí pred montážou bezpodmienečne skontrolovať. Univerzálne hmoždenky, ktoré sú obsiahnuté v balení, používajte jedine pre pevné murivo, ako je betón/tehla. Hmoždenky sa nesmú používať v prípade ľahkého stavebného muriva, dutina tehla, u sádkartónových dosiek alebo iných konštrukcií rámu. U týchto murív je nutné použiť špeciálne hmoždenky! Tieto je možné dostať v špeciálnych predajniach so stavebným materiálom (stavebniny). Pri nedodržaní pokynov nepreberajú výrobcovia/predajci a dodávateľa zodpovednosť za vzniknuté škody.

Upozornění! Před montáží je nutné zkontrolovat stav stěny. Přiložené univerzální hmoždinky jsou určeny pouze k použití pro pevné zdivo jako beton/cihly. Hmoždinky do zdi se nesmí používat u dutinová cihla, zdívka jako porovity stavební kámen, sádkartónová deska nebo jiný měkký materiál. U těchto zdív jsou nutné použít speciální hmoždinky! Jsou k dostání v speciálních prodejních se stavebním materiálem. Při nedodržení těchto pokynů výrobce/prodejece a dovezce neručí za způsobené škody.

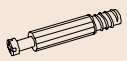

Caution! The wall must be examined before assembly. The included universal wall plugs are only suitable for using in firm masonry such as concrete block or brick. Do not use the wall plugs masonry such as hollow brick, lightweight block, surfaces such as gypsum plasterboard or other framing systems. If applicable, particular wall plugs must be used! These are available at a specialised store (hardware store). In case of non-compliance, the manufacturer/retailer or importer do not assume liability.

Achtung! Die Wandbeschaffenheit ist vor der Montage unbedingt zu prüfen. Die beigelegten Universaldübel sind ausschließlich nur zur Verwendung für festes Mauerwerk wie Beton/Ziegel. Die Mauerdübel dürfen nicht bei Mauerwerk wie Hohlraumziegel, Leichtbausteinen, Gipskartonplatte oder anderer Rahmenbauweise verwendet werden. Bei diesen Mauerwerken sind gegebenenfalls Spezialdübel zu verwenden! Diese sind in einem Fachgeschäft (Baumarkt) erhältlich. Bei Nichterhaltung wird seitens Produzenten/Händler und Importeur keine Haftung übernommen.

Vigyázat! Szerelés előtt a falfelületet feltétlenül vizsgálja meg. A mellékelt univerzális tiplik kizárólag stabil falazathoz használható mint például beton/tégla. A fal tiplik nem használható könnyű építőkövekhez, üreg tégla, gipszkarton lapokhoz vagy más fávázás építményekhez. Ezekhez a falfelületekhez csak speciális tiplik használhatóak, melyek szaküzletekben (barkácsáruházakban) beszerezhetőek. Fentiek figyelmen kívül hagyása esetén a gyártó/kereskedő vagy forgalmazó nem vállal felelősséget.

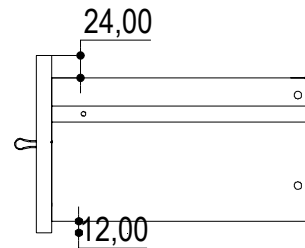
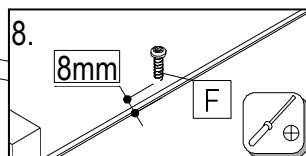
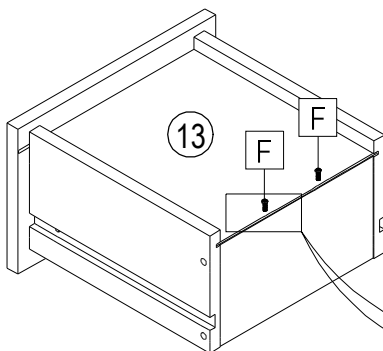
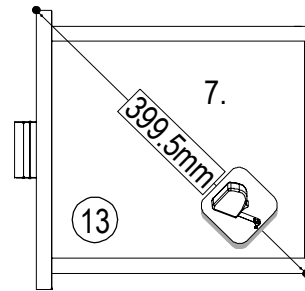
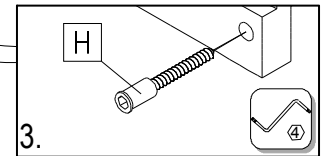
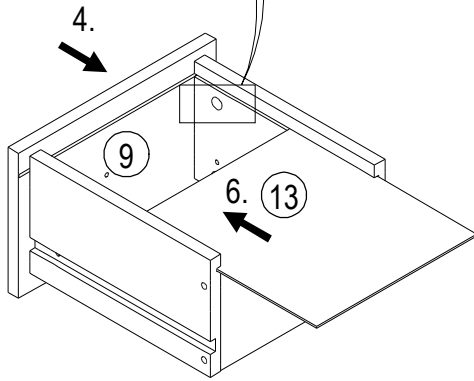
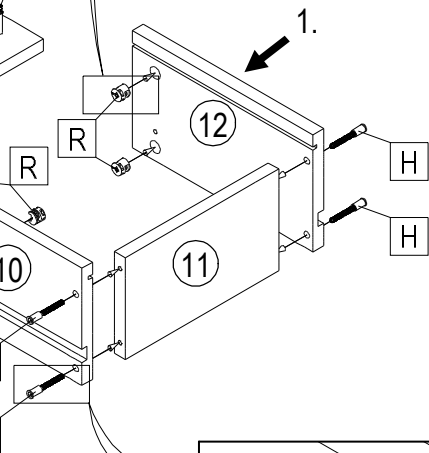
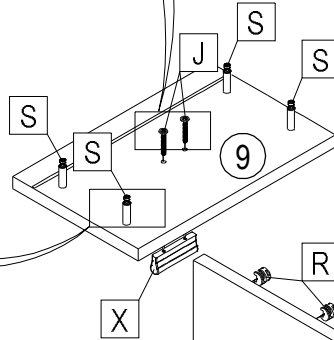
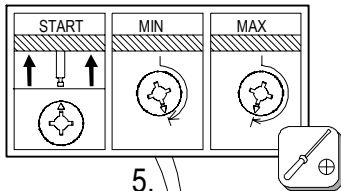
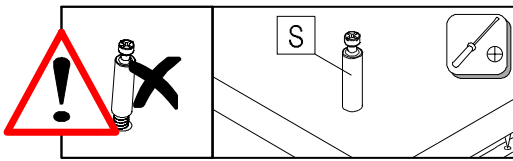
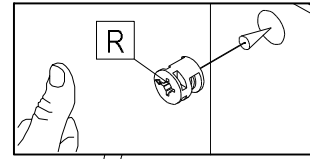
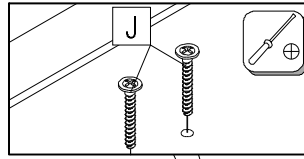
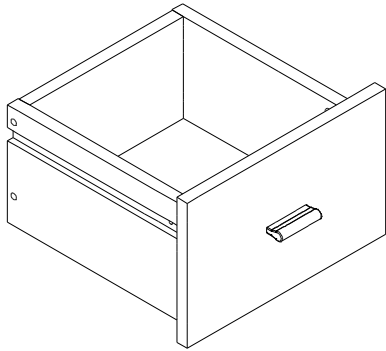

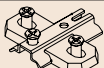

					
F	H	J	R	S	X
2x	4x	2x	4x	4x	1x
					R=32

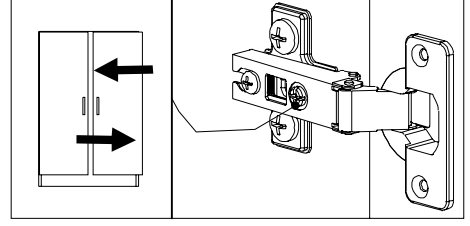
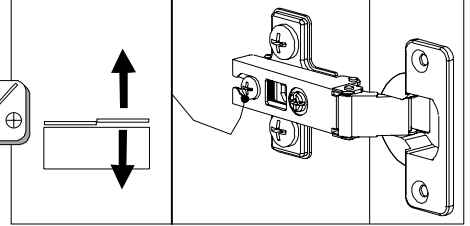
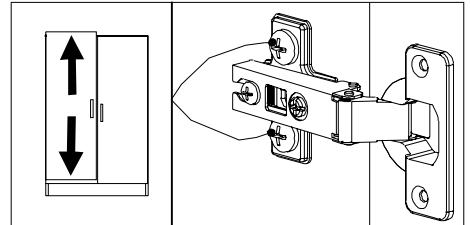
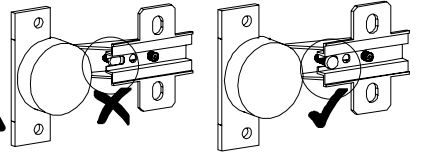
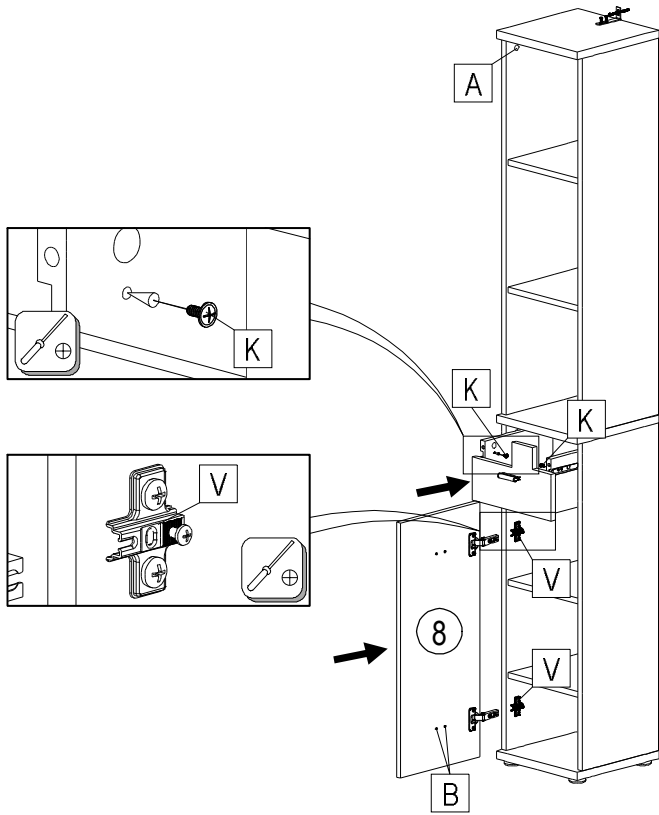

				A			
A	14x	B	2x	K	2x	V	2x

A



				B			
A	14x	B	2x	K	2x	V	2x

B

