

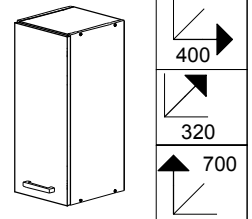

NOVA PLUS
NOPL-005-0H





! V PRÍPADE REKLAMÁCIE JE POTREBNÉ NAHLÁSIŤ
 VÝROBNÉ ČÍSLO VIDITEĽNÉ NA ETIKETE **!**

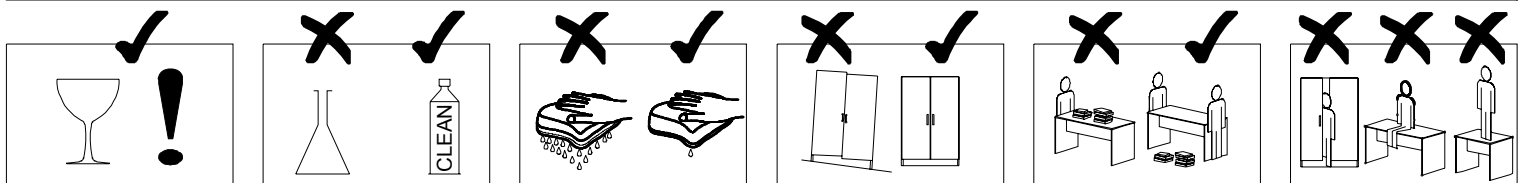
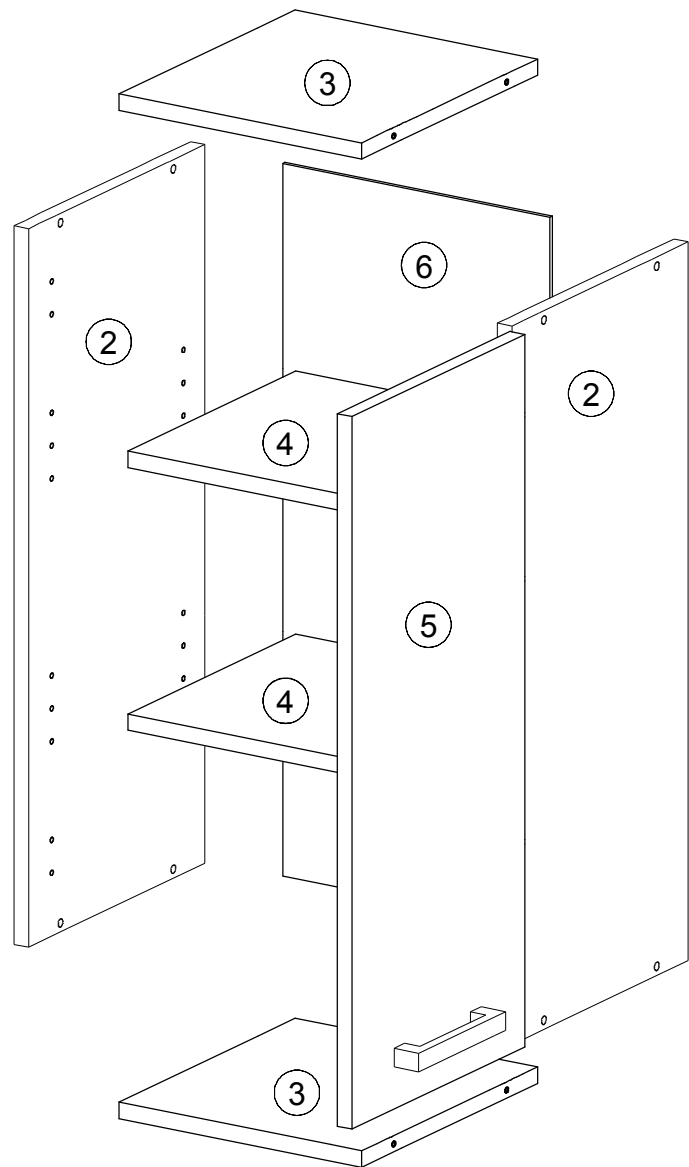

A 8x	B 8x	C 20x Ø1,6x20	D 1x	E 2x	F 2x	G 8x	H 8x Ø3,5x15	J 2x Ø10	K 2x
L 2x Ø5x60	1h 15min		4	5,5 x 125	≤ 0,5 kg	0,6m	3m		Ø10mm

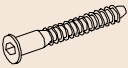
ID	ID	Part	Qty	Ratio
00302	②	700*300*16	2x	1/1
00310	③	368*299*16	2x	1/1
00311	④	368*285*16	2x	1/1
00358	⑤	694*396*16	1x	1/1
00857	⑥	694*396*2,5	1x	1/1

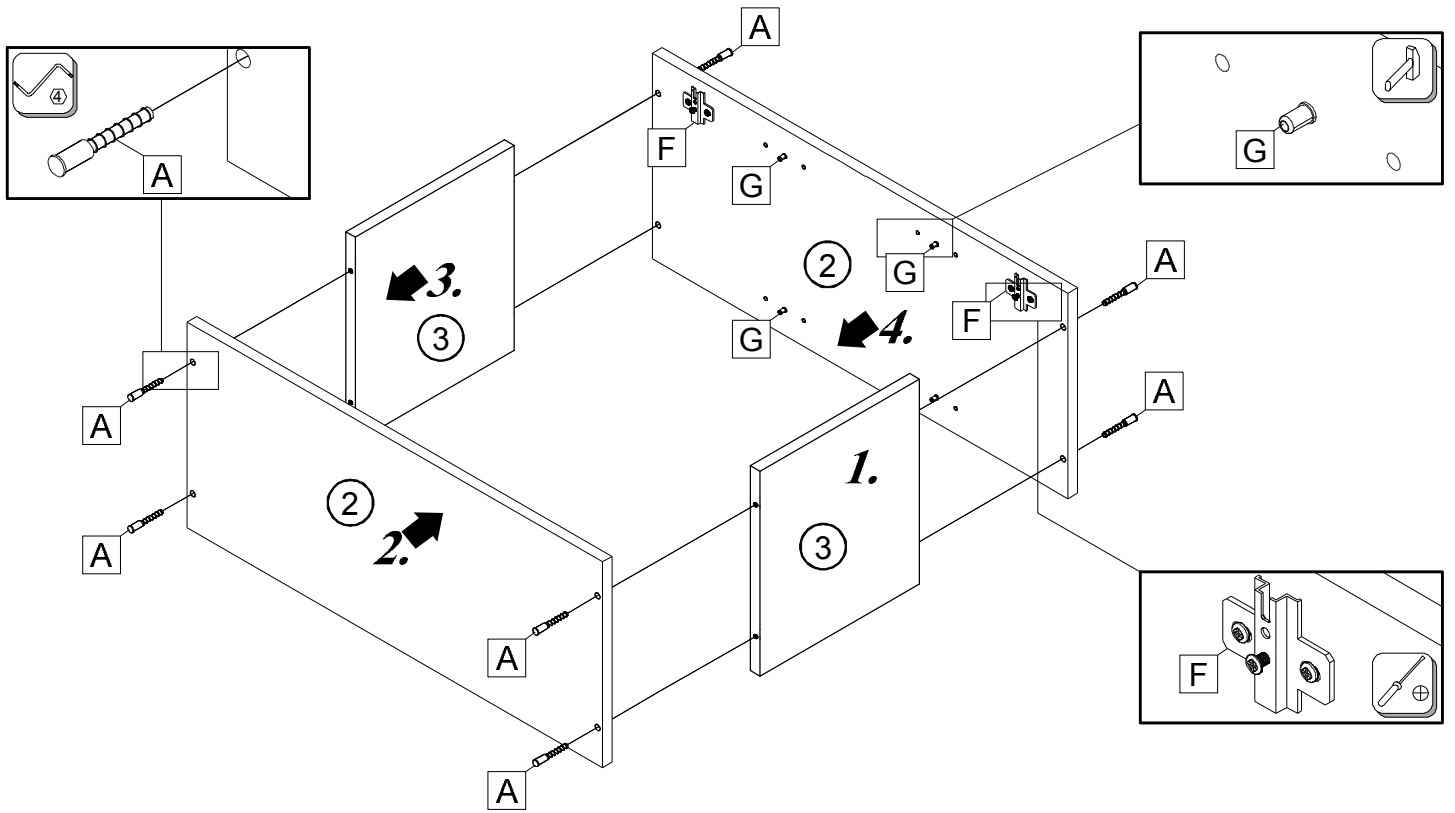

		
A 8x	G 8x	F 2x



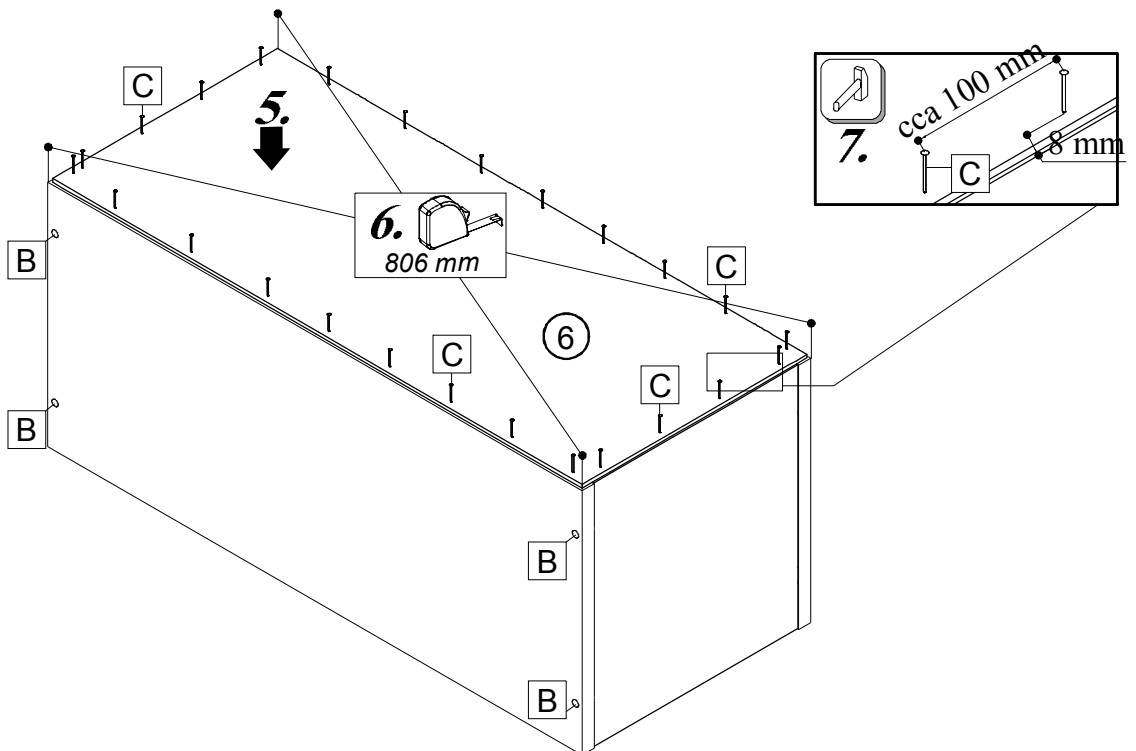

	
C 20x	B 8x

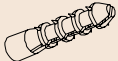

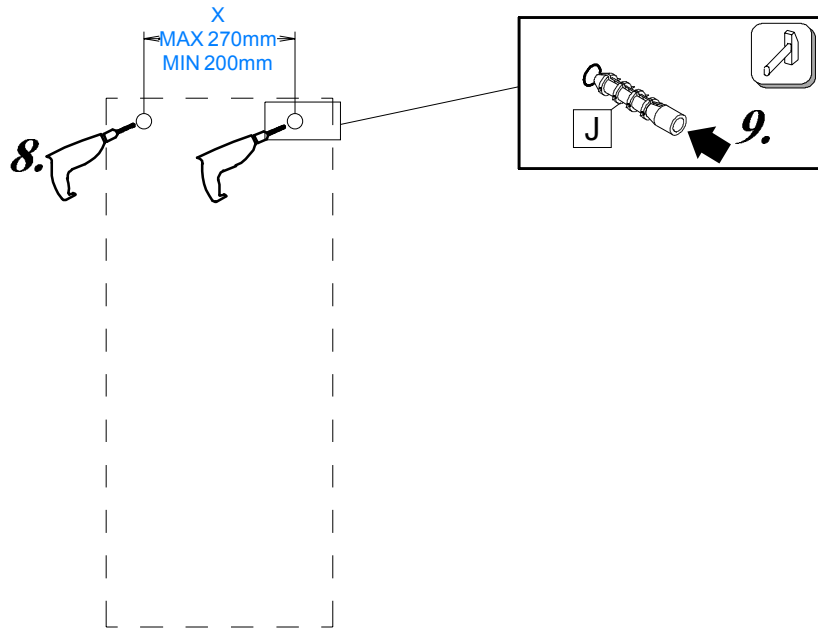

	J	2x
--	---	----

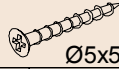

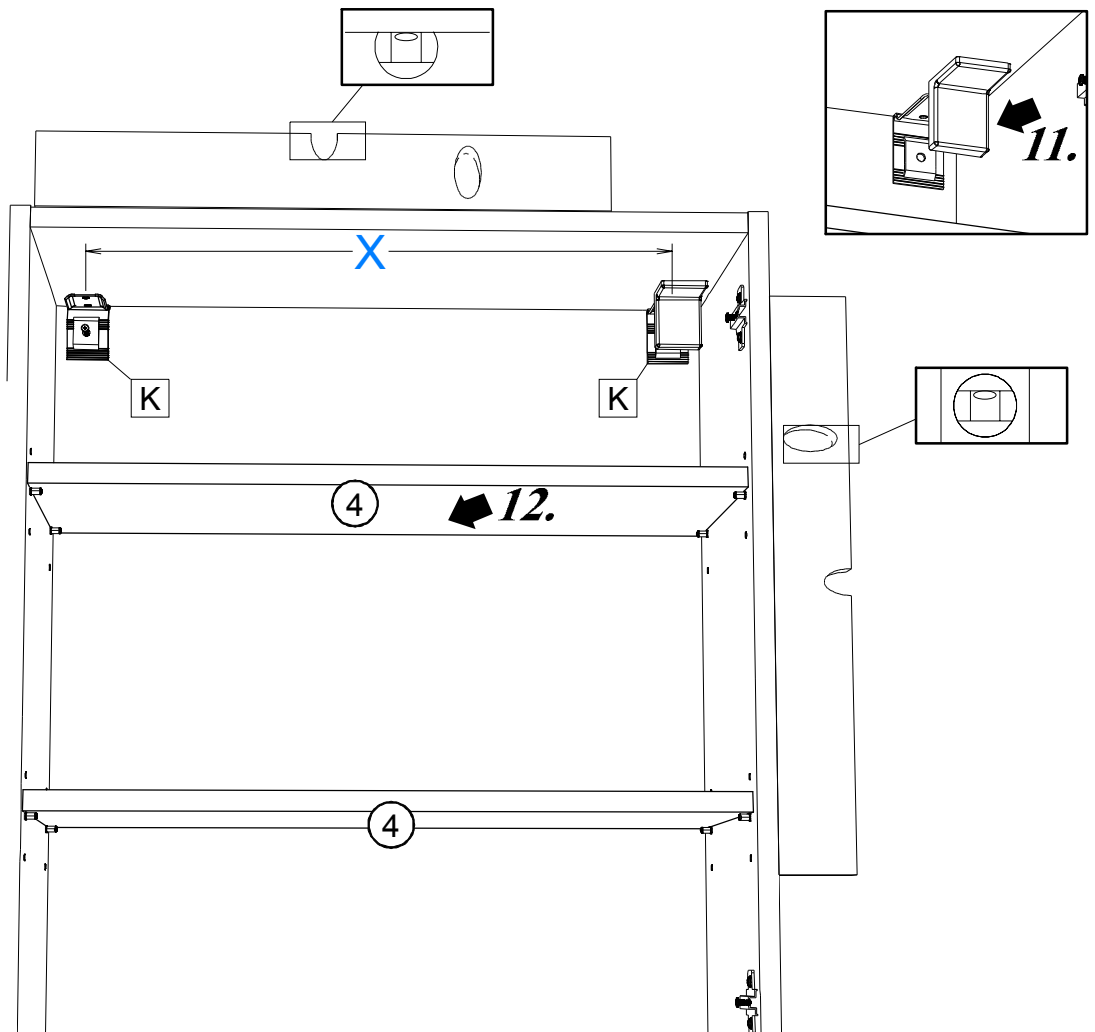
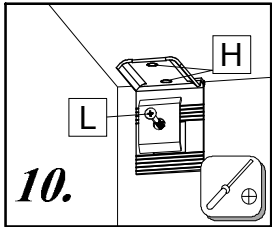
		
Ø3,5x15		Ø5x50
H	K	L
4x	2x	2x

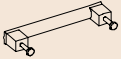

		
D 1x	E 2x	H 4x
Ø3,5x15		

