

D 2x	E 4x	H 8x

13.

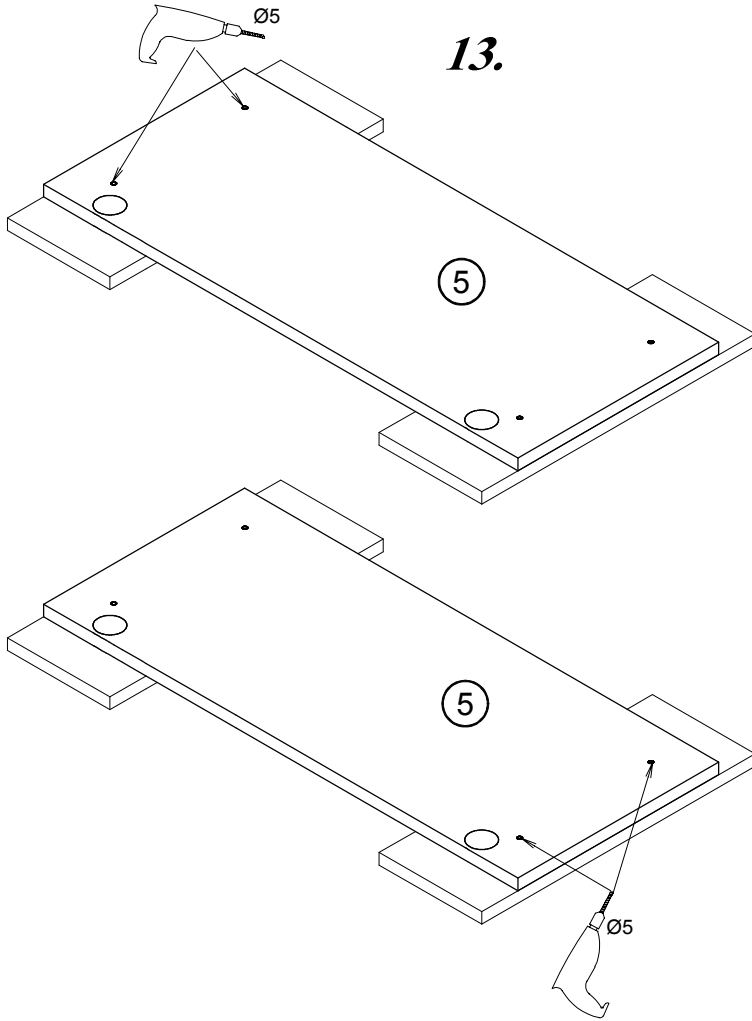

! a=b !

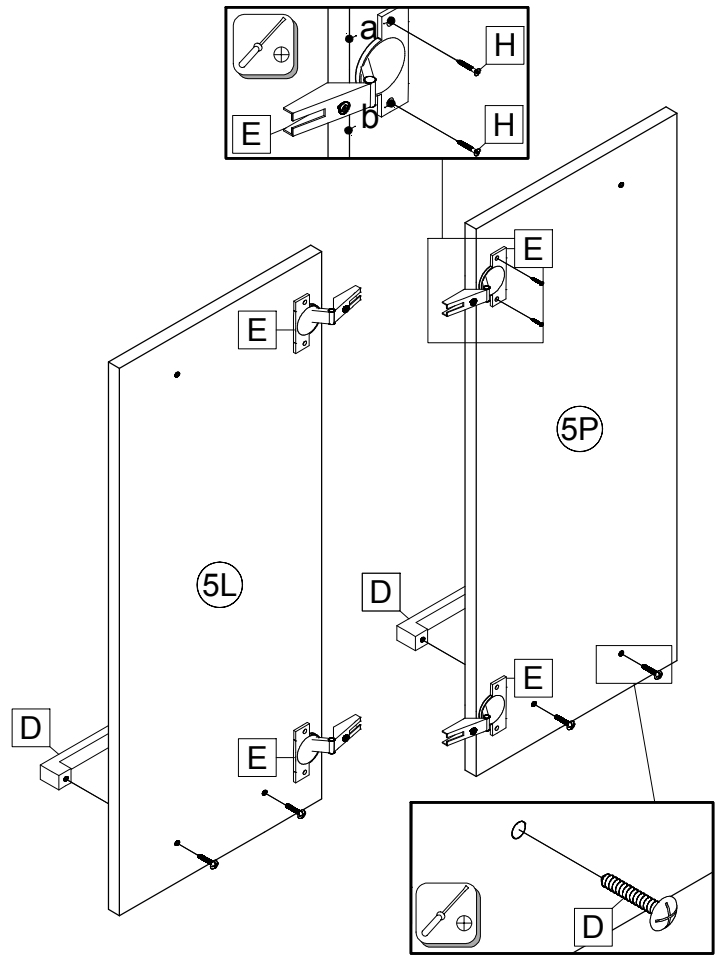



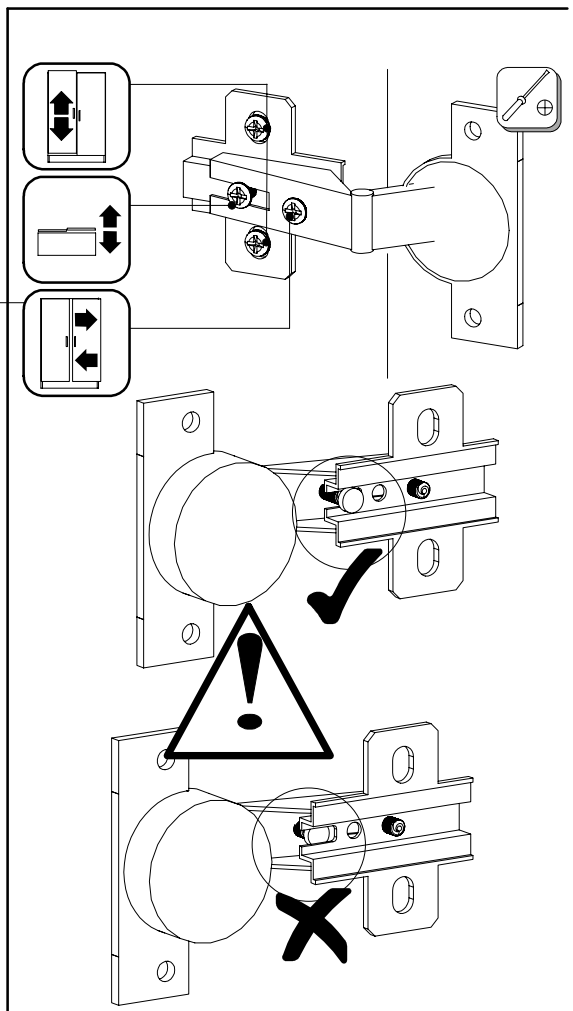
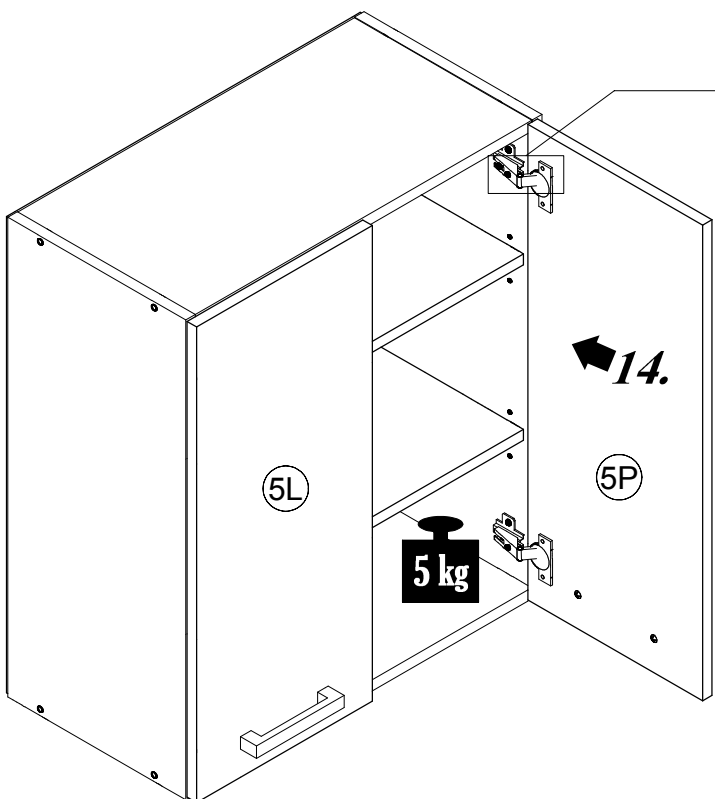



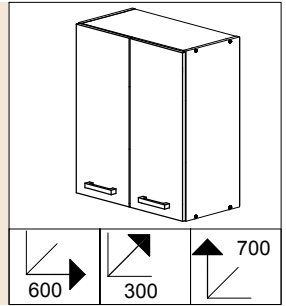

14.



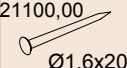
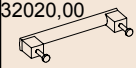



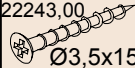

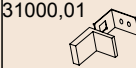

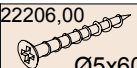
NOVA PLUS NOPL-007-0H

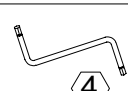

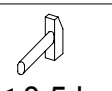
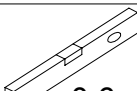
									
A	B	C	D	E	F	G	H	J	K
8x	8x	30x	2x	4x	4x	8x	12x	2x	2x

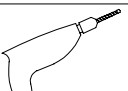
									
L	0h 45min		4	PZ 2	≤ 0,5 kg	0,6m	3m		Ø10mm
2x									

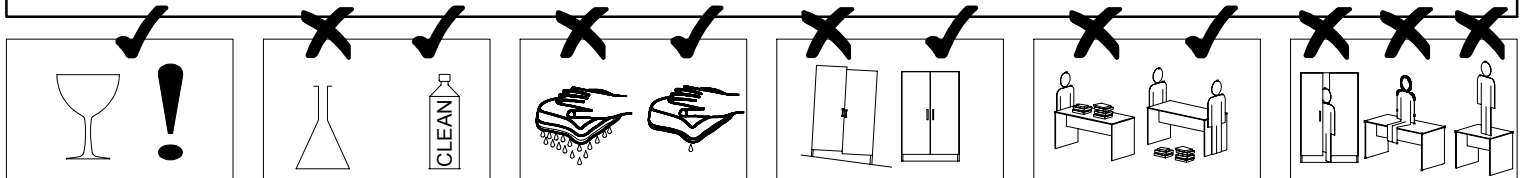
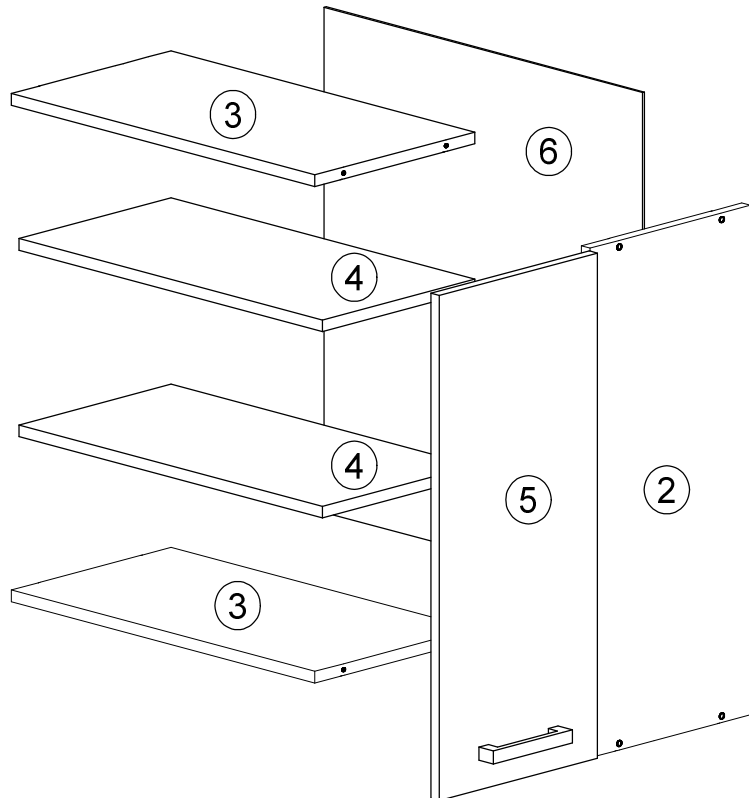
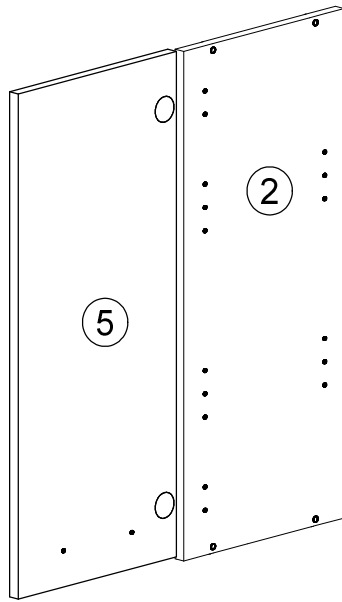

ID				
00302	②	700*300*16	2x	1/1
00320	③	568*299*16	2x	1/1
00321	④	568*285*16	2x	1/1
00306	⑤	694*296*16	2x	1/1
00324	⑥	694*596*2,5	1x	1/1

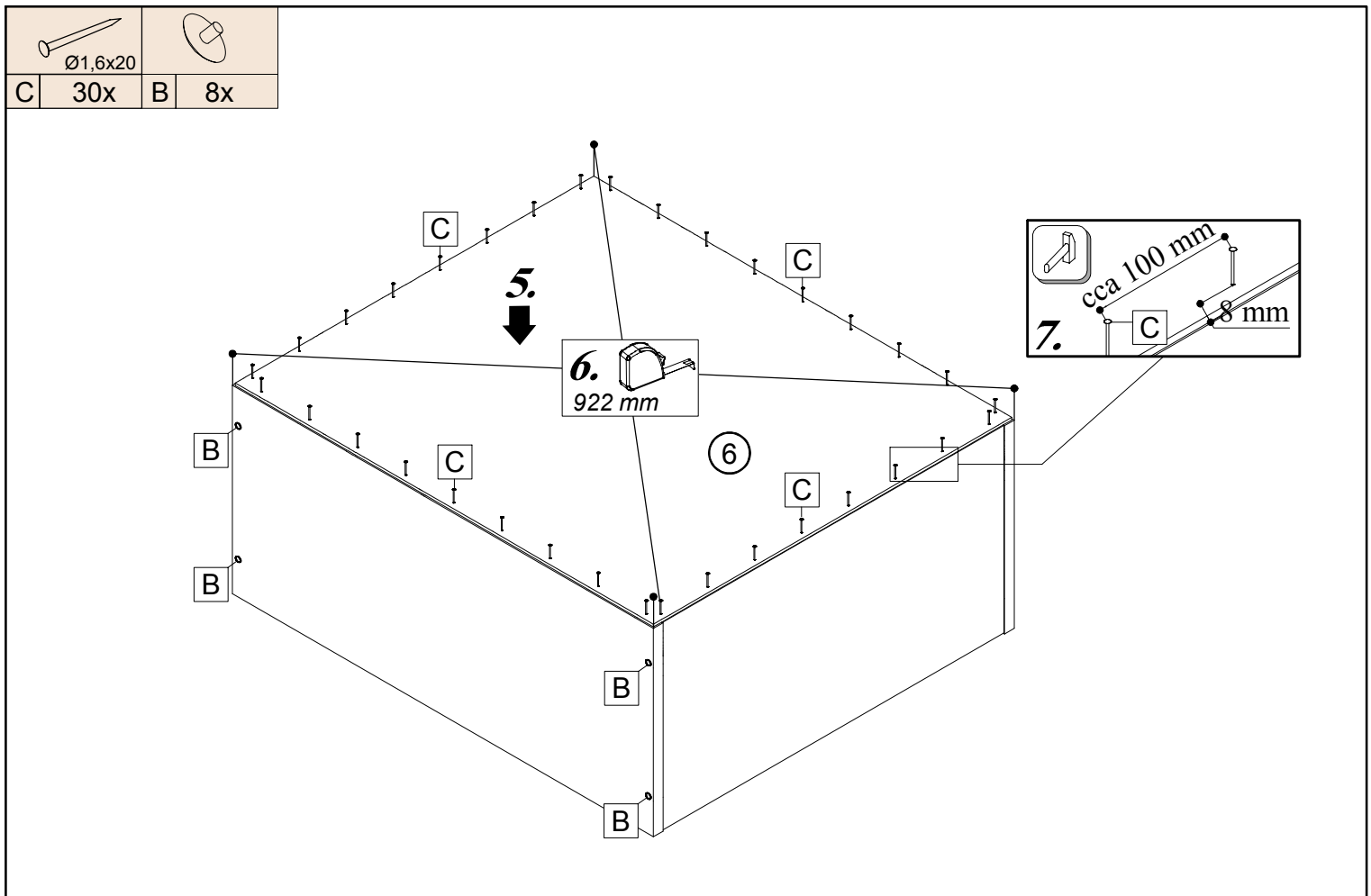
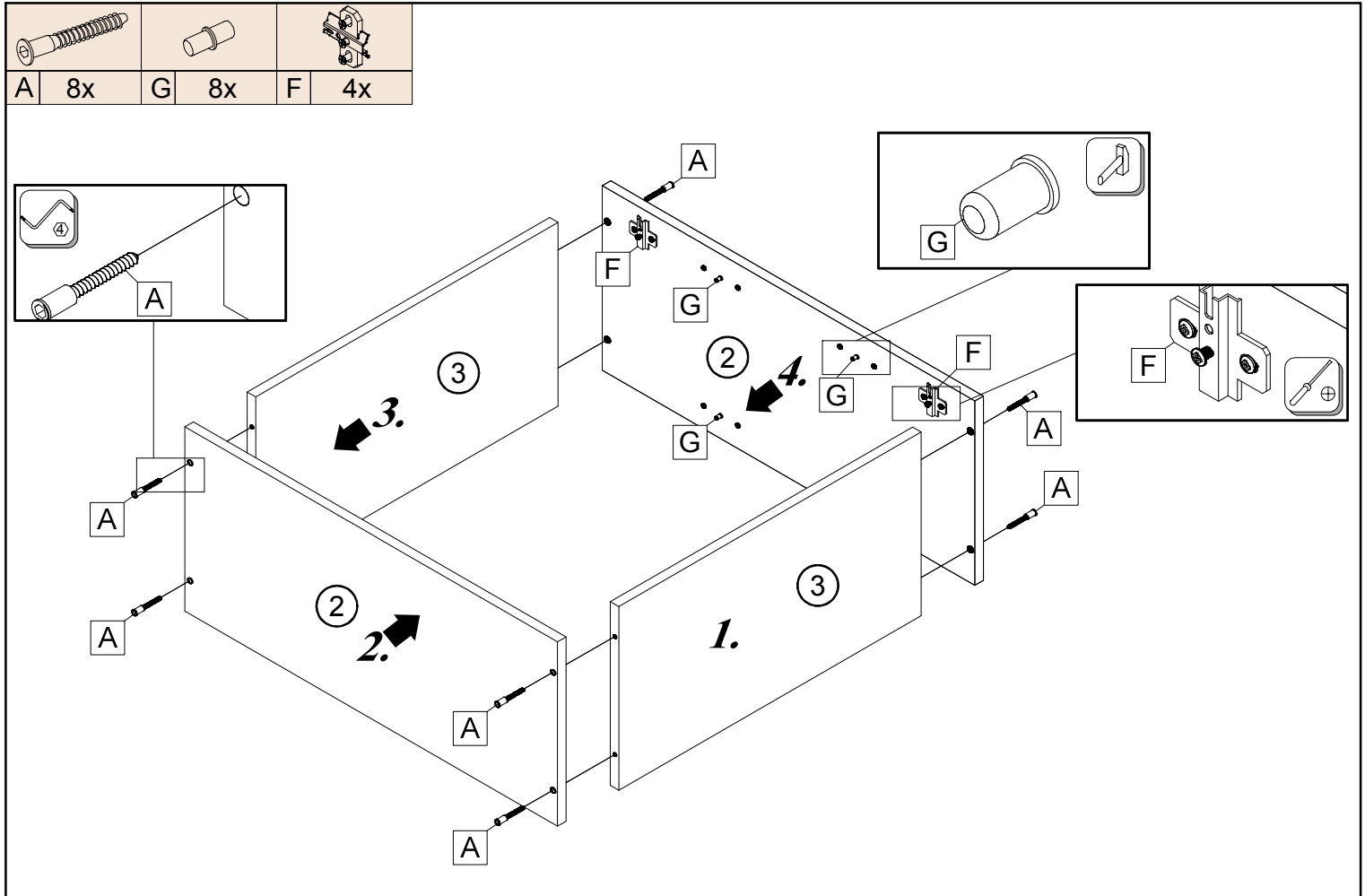

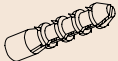

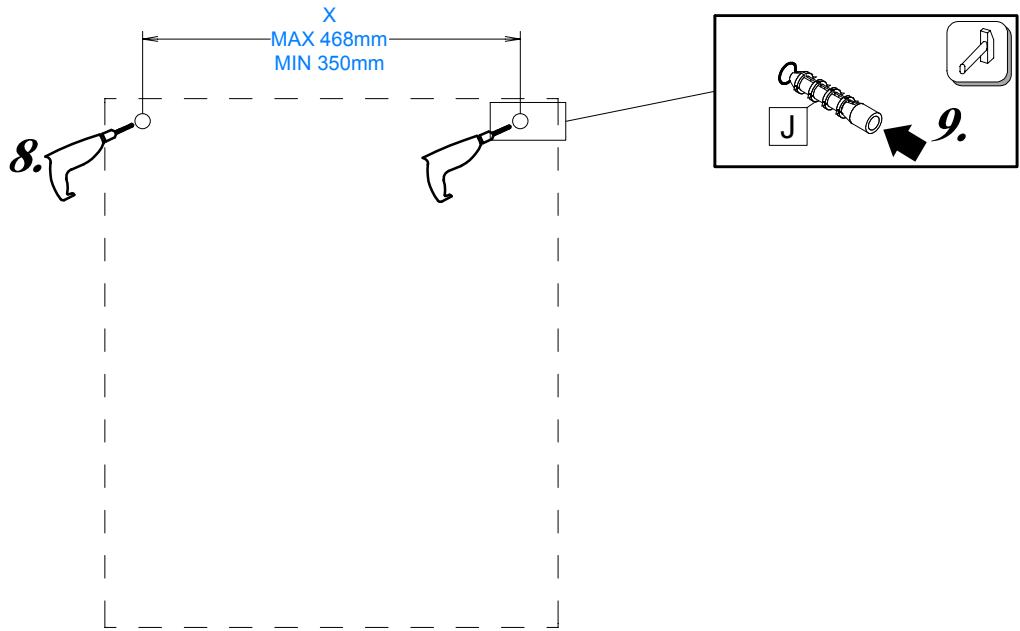
	
J	2x

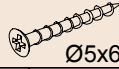

			
Ø3,5x15		Ø5x60	
H	4x	K	2x
		L	2x

