

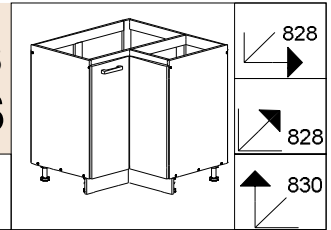

NOVA PLUS NOPL-061-RS







! V PRÍPADE REKLAMÁCIE JE POTREBNÉ NAHLÁSIŤ
 VÝROBNÉ ČÍSLO VIDITEĽNÉ NA ETIKETE **!**

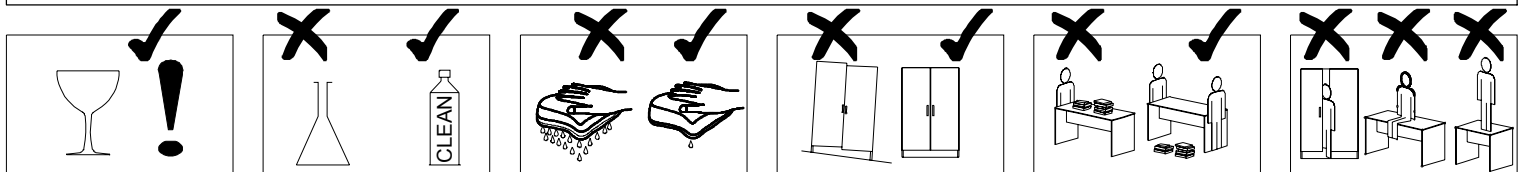
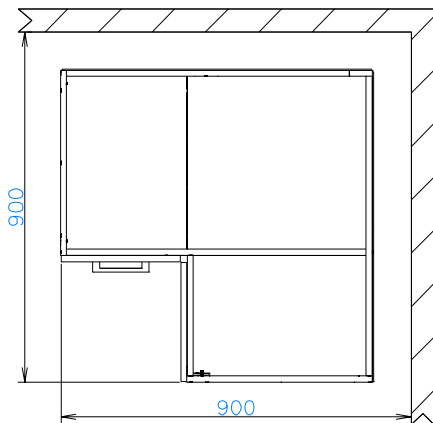
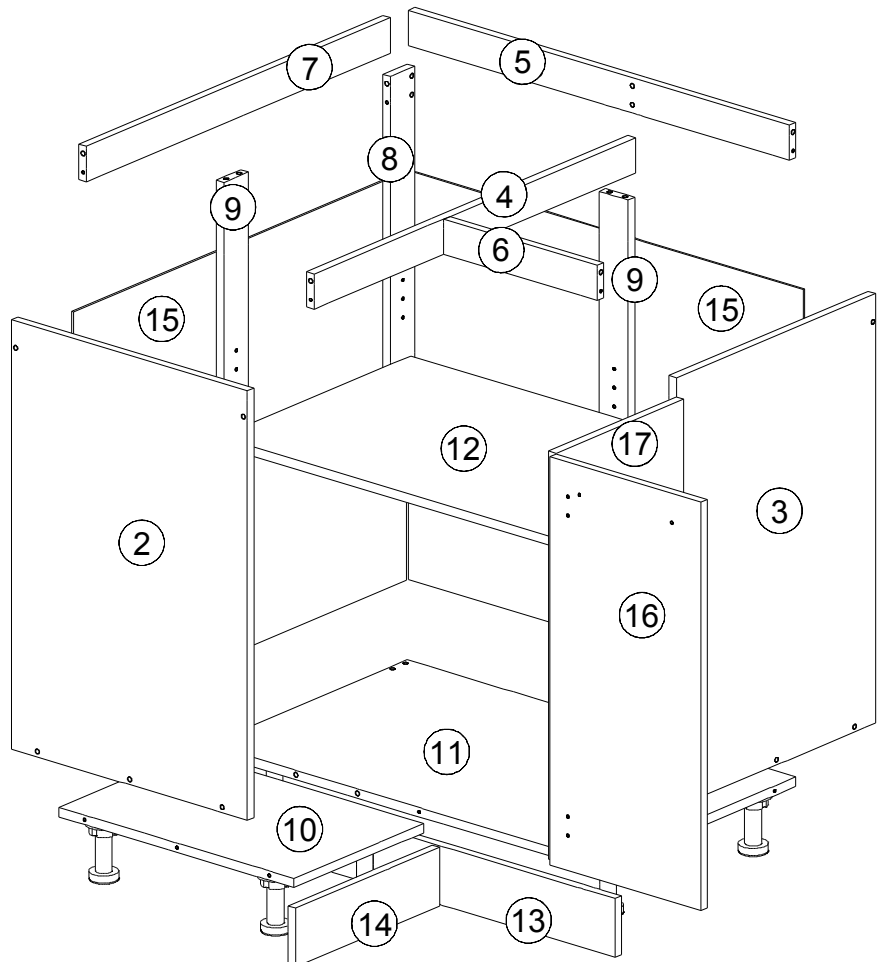

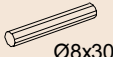
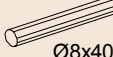
A 15x	B 15x	C 7x	D 40x	E 23x	F 1x	G 10x	H 3x	J 3x	K 7x
L 10x	M 48x	N 4x	P 8x	Q 2x	R 2x	S 4x	T 4x		
1h 10min	4		≤ 0,5 kg		3m		Ø5		

01142	②	730*490*16	1x	1/1
01143	③	730*490*16	1x	1/1
00402	④	792*60*16	1x	1/1
00403	⑤	792*60*16	1x	1/1
00404	⑥	319*60*16	1x	1/1
00405	⑦	748*60*16	1x	1/1
00406	⑧	713*60*16	1x	1/1
00407	⑨	653*60*16	2x	1/1
00408	⑩	319*489*16	1x	1/1
00409	⑪	808*489*16	1x	1/1
00410	⑫	791*470*16	1x	1/1
00411	⑬	824*100*16	1x	1/1
00412	⑭	354*100*16	1x	1/1
00456	⑮	694*820*2,5	2x	1/1
00414	⑯	694*314*16	1x	1/1
00415	⑰	694*314*16	1x	1/1



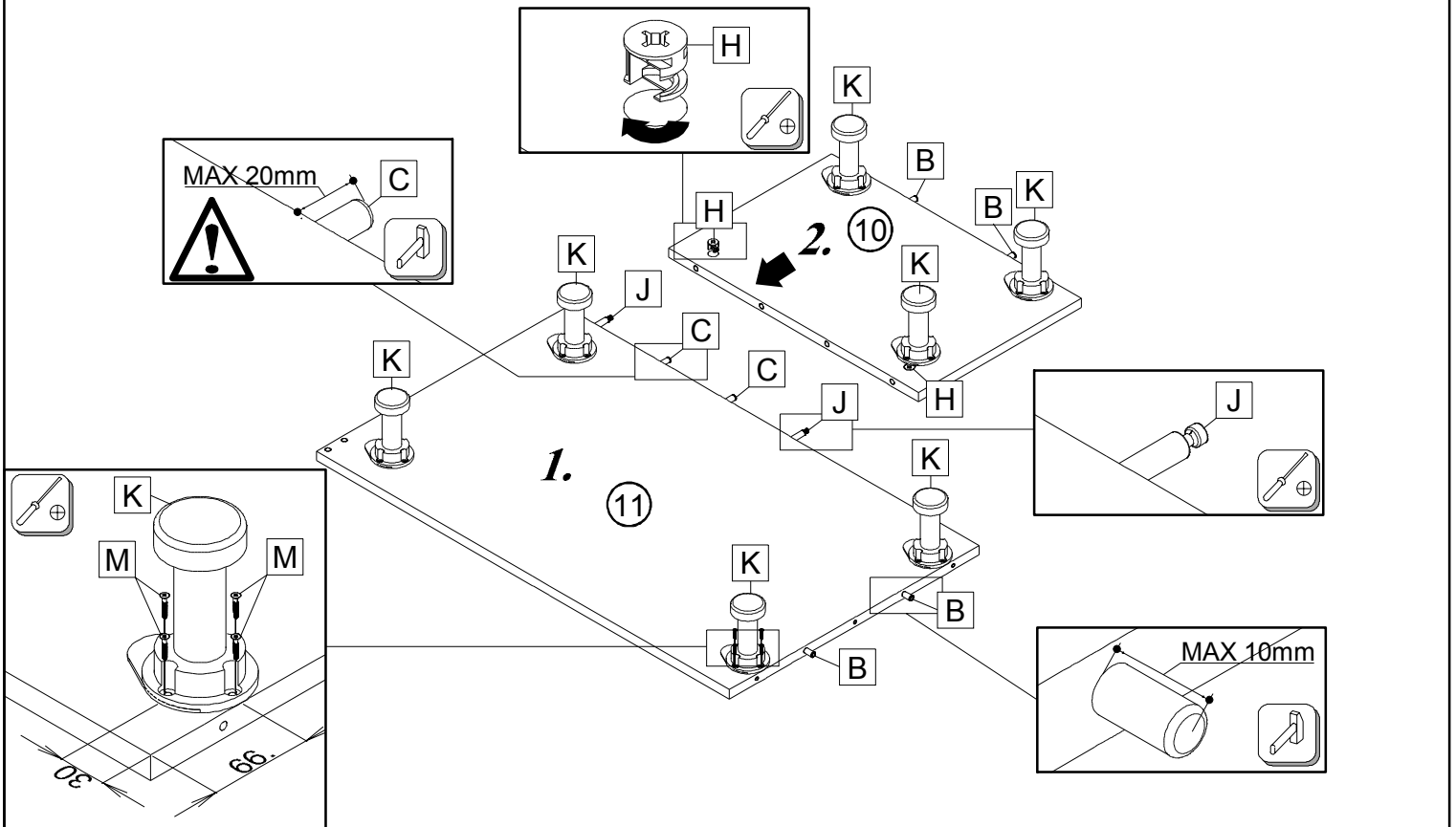

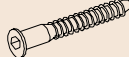
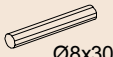
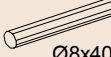

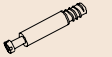

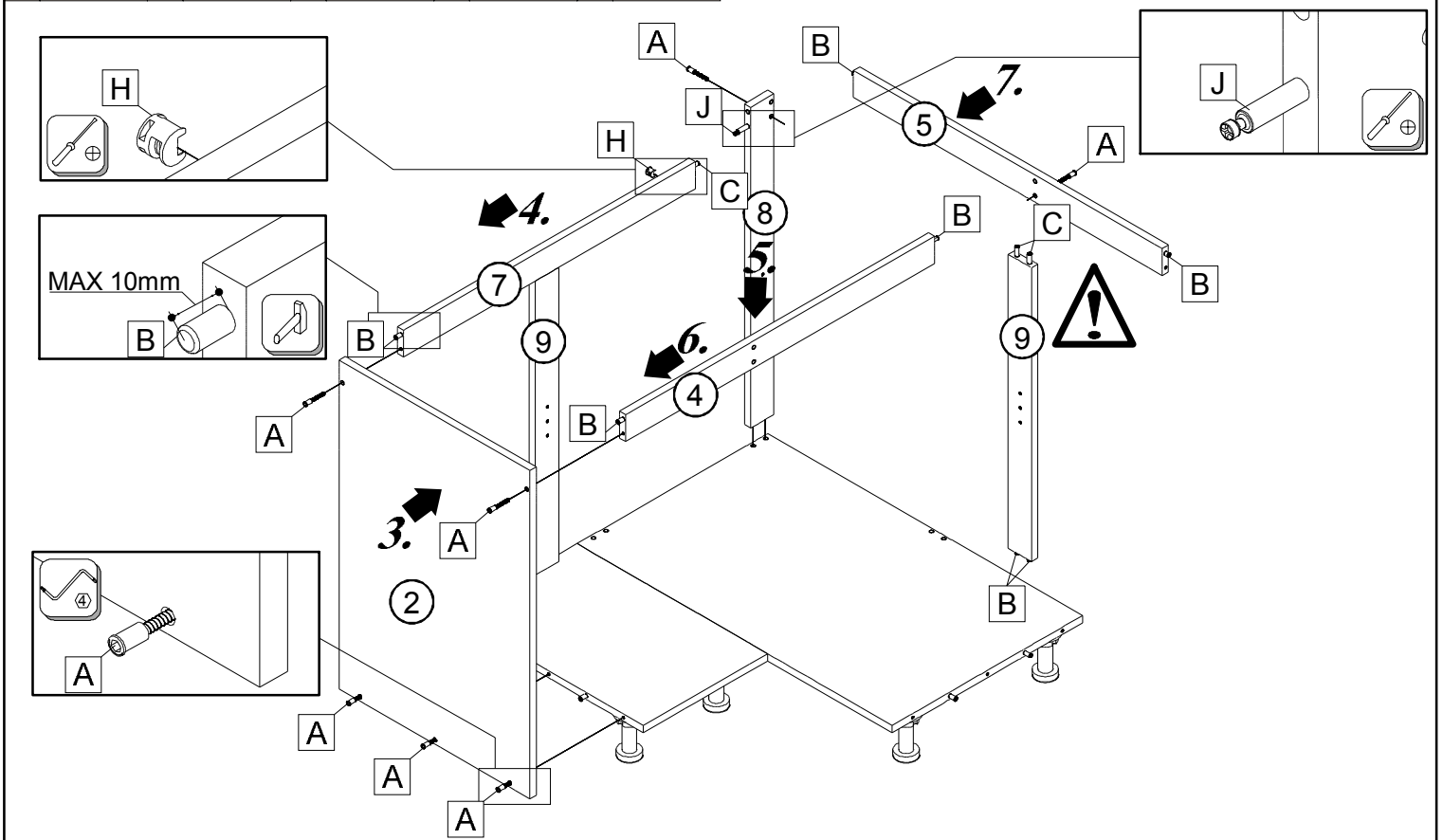

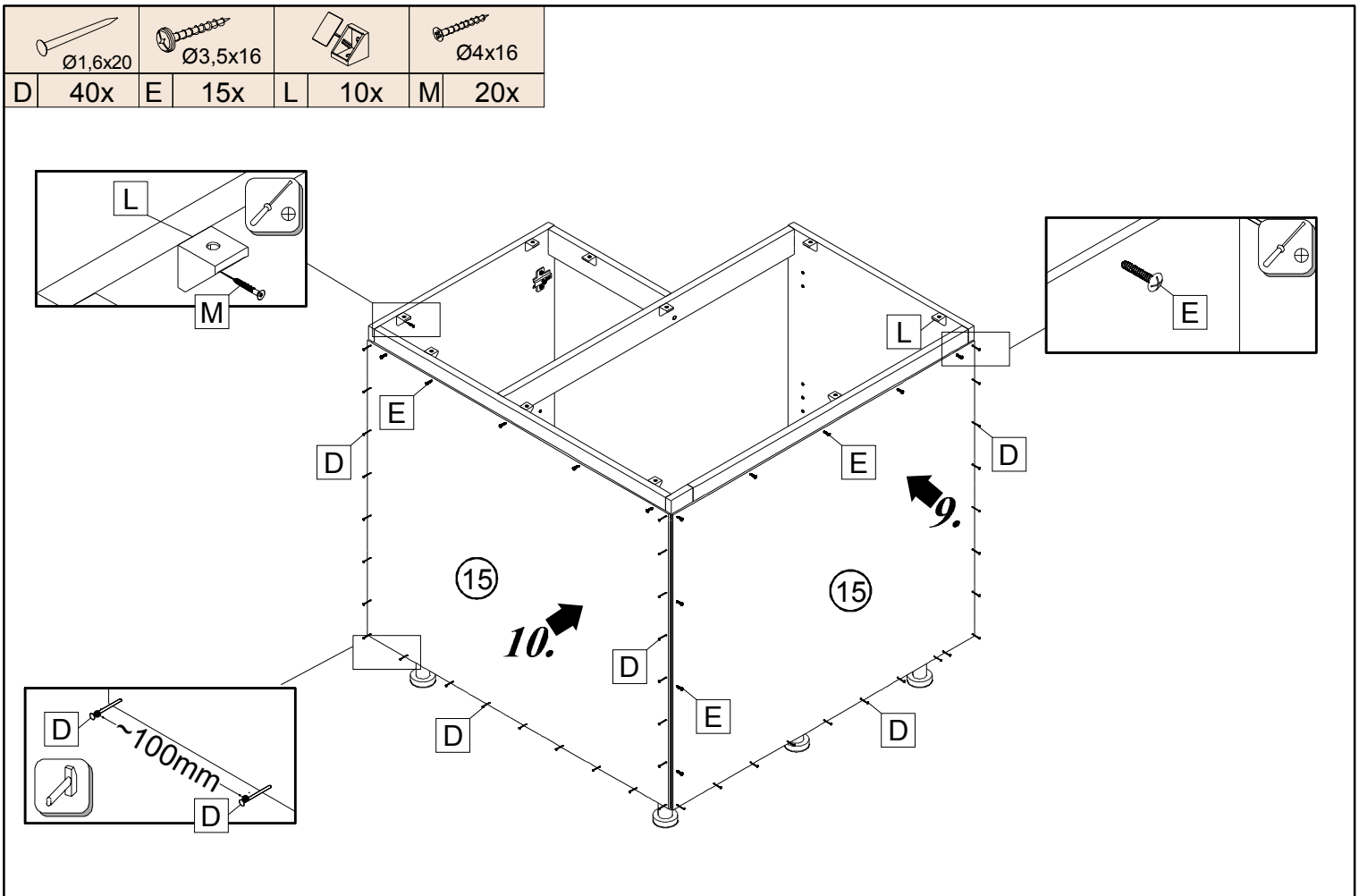
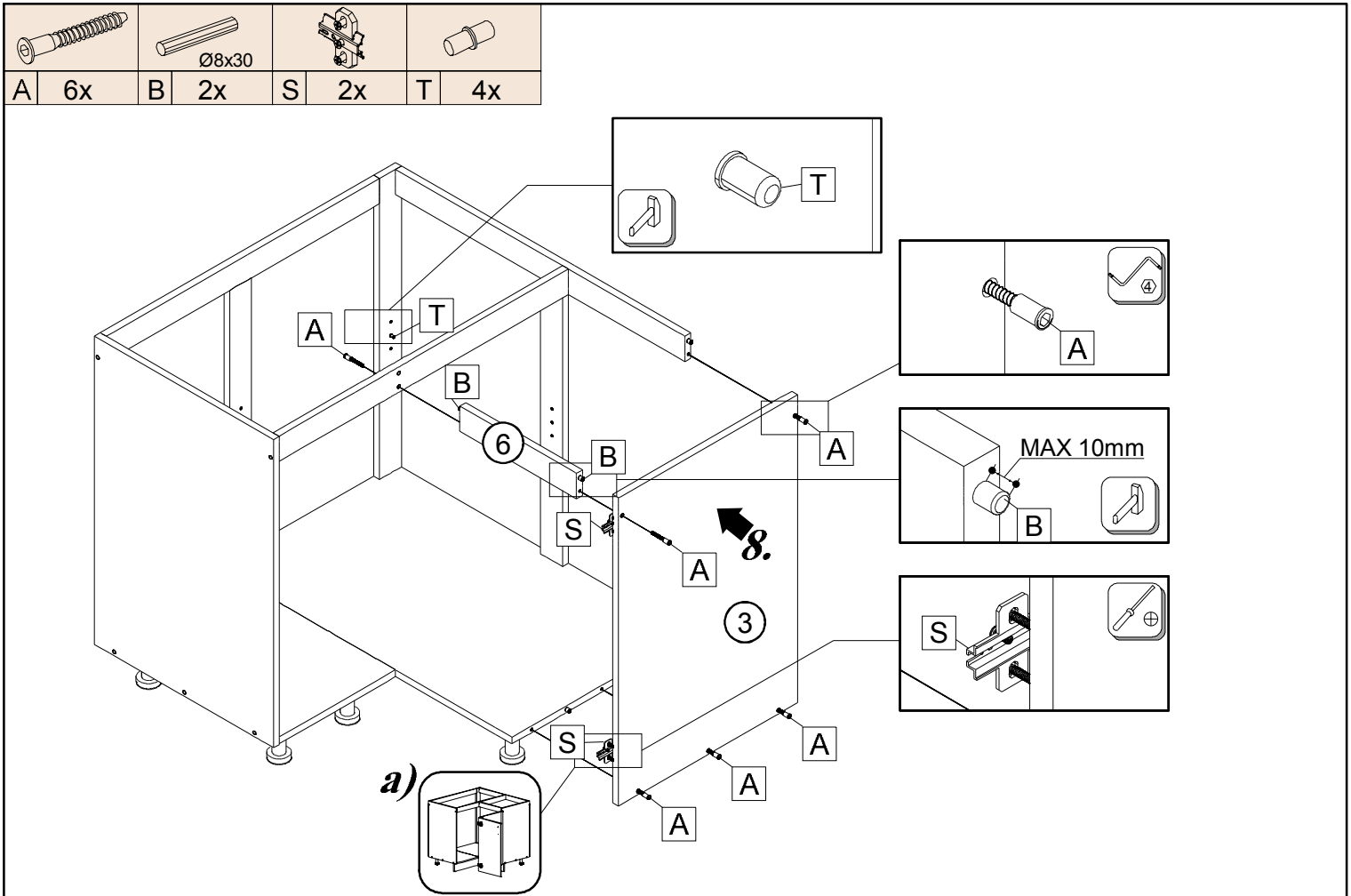
					
B 4x	C 2x	H 2x	J 2x	K 7x	M 28x

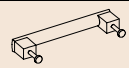

				
A 9x	B 9x	C 5x	H 1x	J 1x





							
E 8x	F 1x	G 10x	N 4x	P 8x	Q 2x	R 2x	S 2x

11.

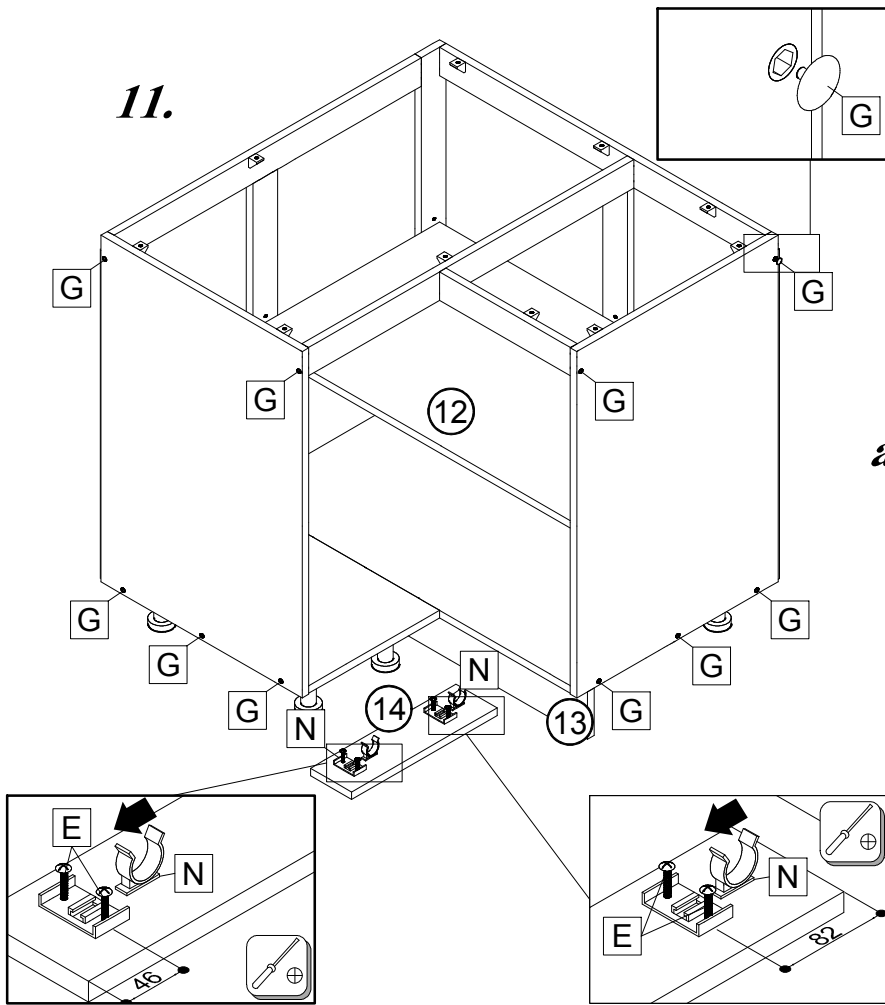

12.

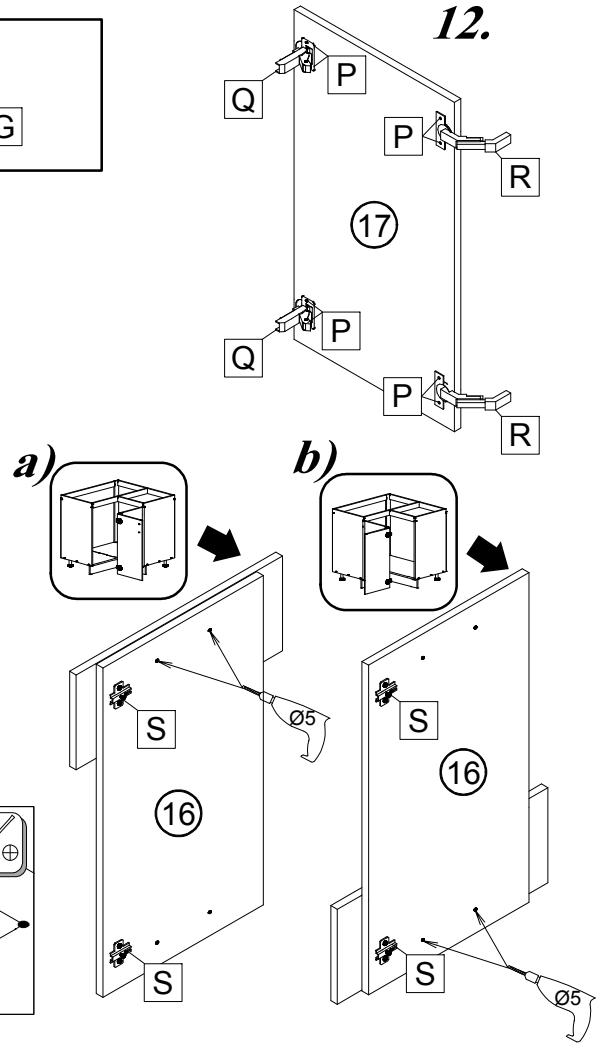

SK ŠABLÓNA
 CZ ŠABLONA
 HU SABLON
 DE SCHABLONE

