

# AURORA G602F

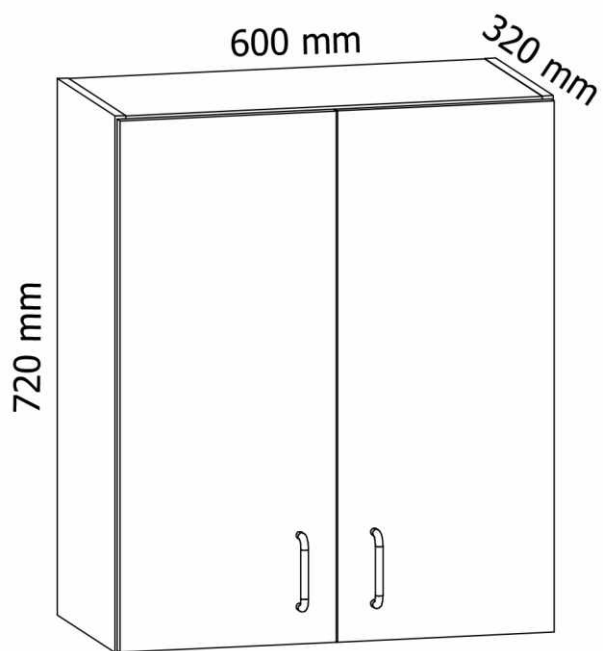
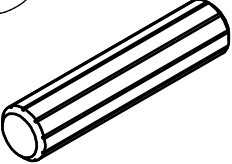
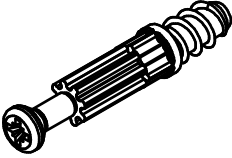
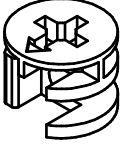
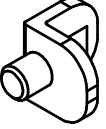
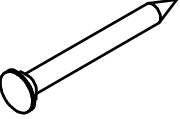
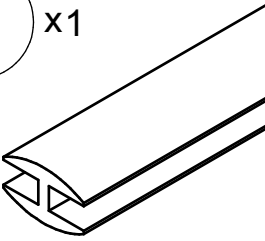
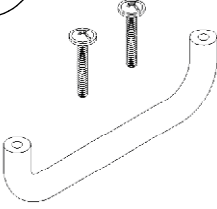
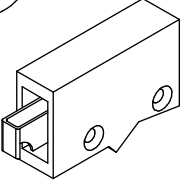
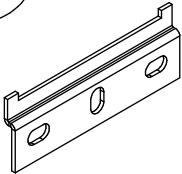
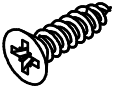
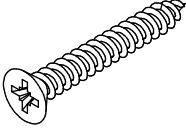
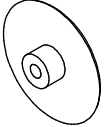
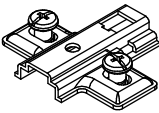
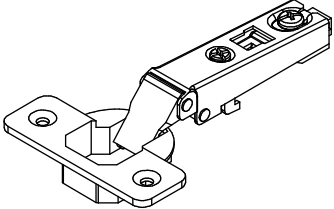

-

<p><b>A</b> x8</p>  <p>Ø8x35mm</p>	<p><b>B</b> x8</p> 	<p><b>C</b> x8</p>  <p>Ø15x12mm</p>	<p><b>E</b> x4</p> 
<p><b>G</b> x25</p> 	<p><b>H</b> x1</p>  <p>715 mm</p>	<p><b>M</b> x2</p> 	<p><b>N1</b> x2</p> 
<p><b>N2</b> x2</p> 	<p><b>W2</b> x8</p>  <p>Ø3,5x16</p>	<p><b>W8</b> x4</p>  <p>Ø4x30mm</p>	<p><b>Y</b> x8</p>  <p>Ø18 mm</p>
<p><b>Zc</b> x4</p>  <p>Zc-1</p>  <p>Zc-2</p>			

# 1

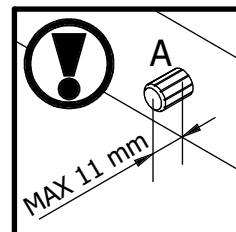
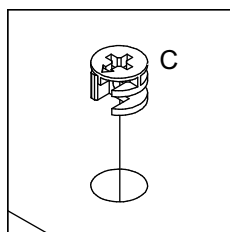
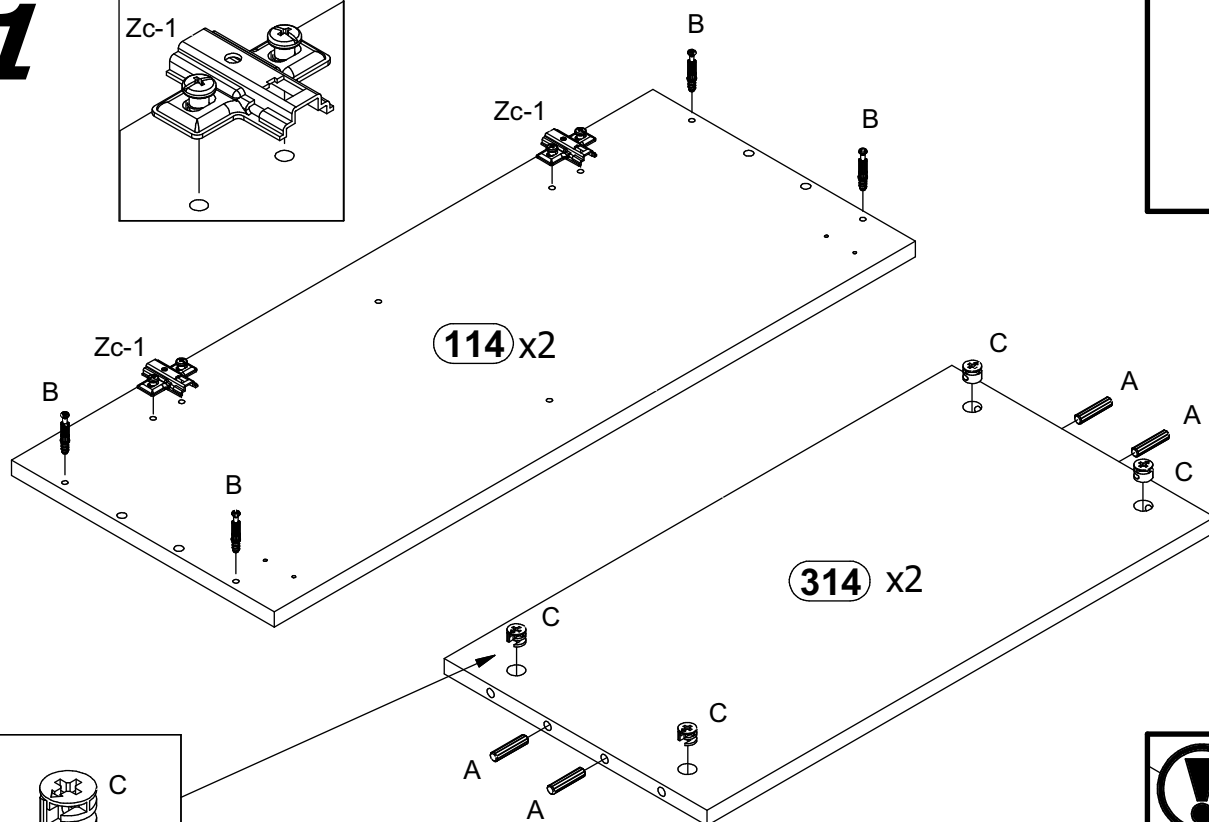
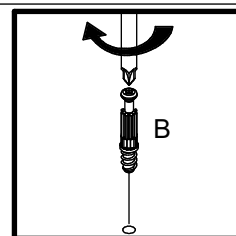
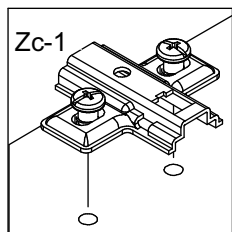

# 2

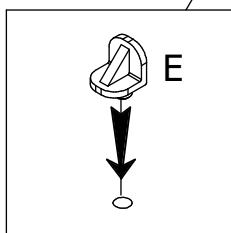
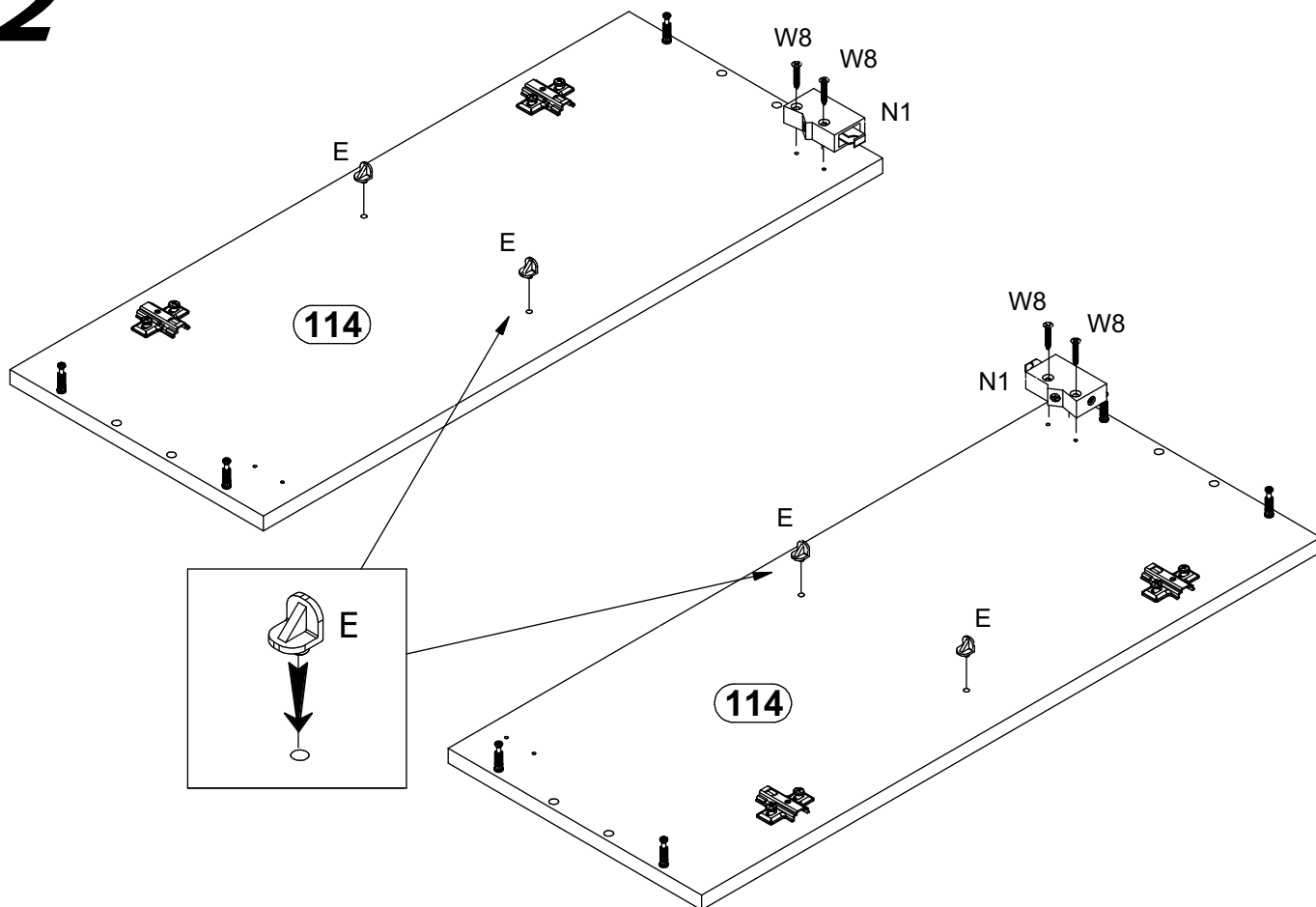

# 3

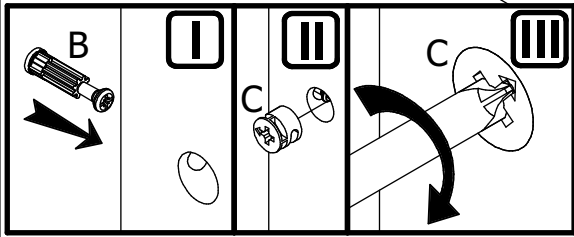
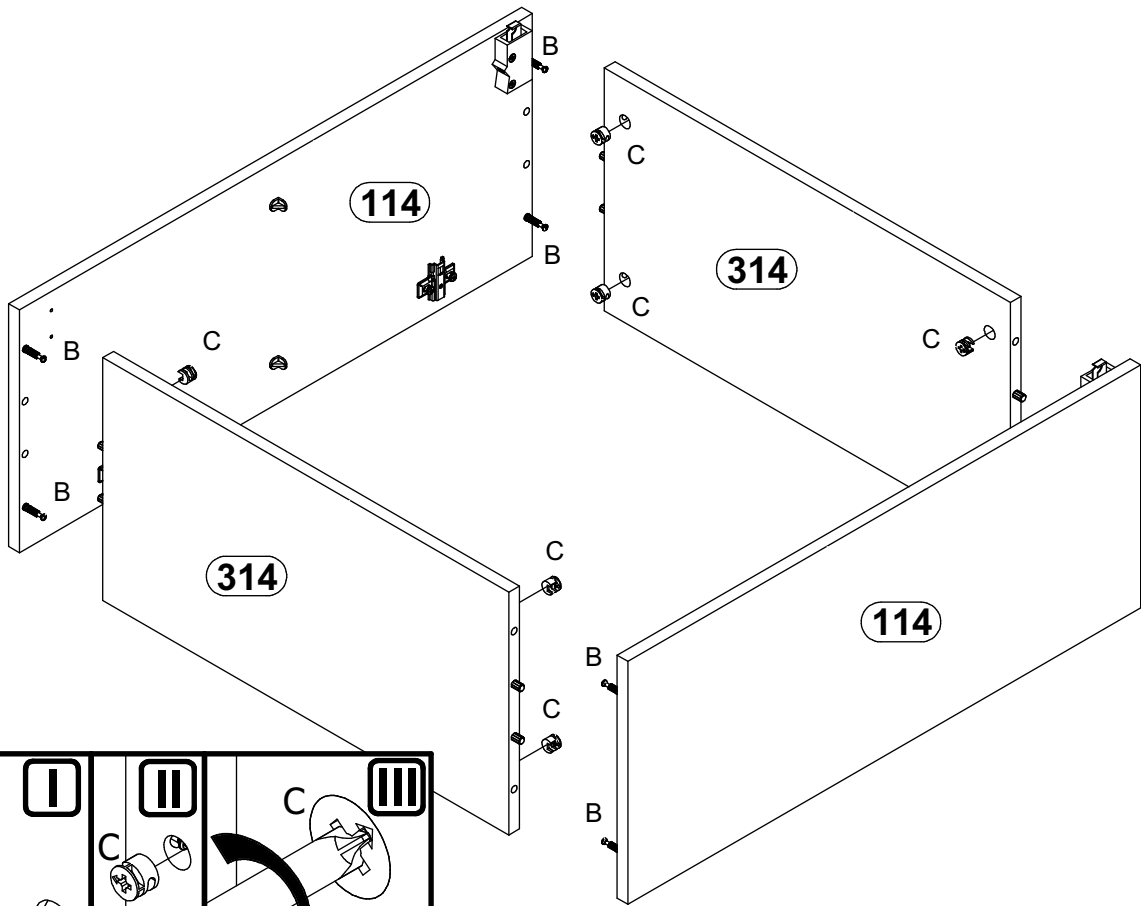

# 4

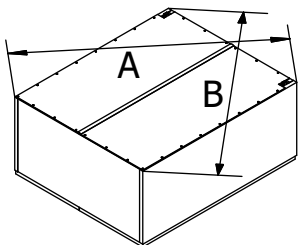
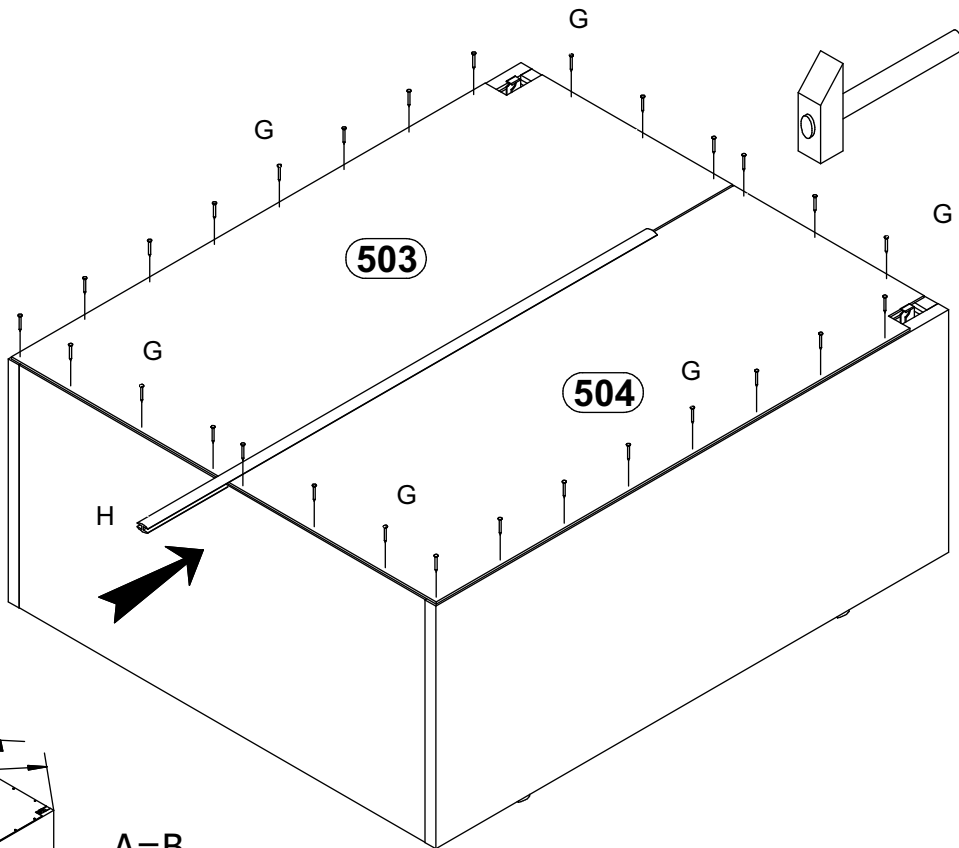

# 5

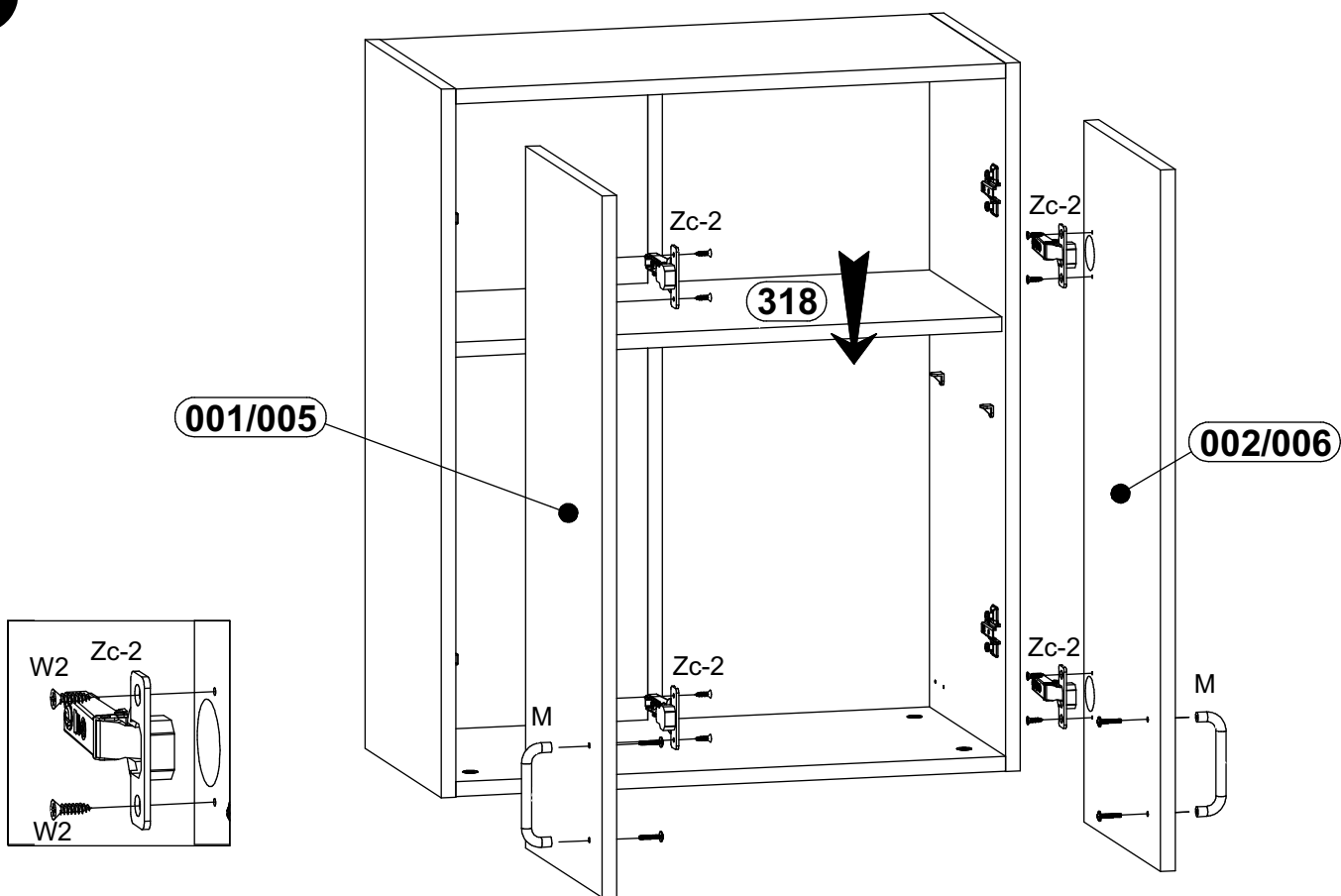

# 6

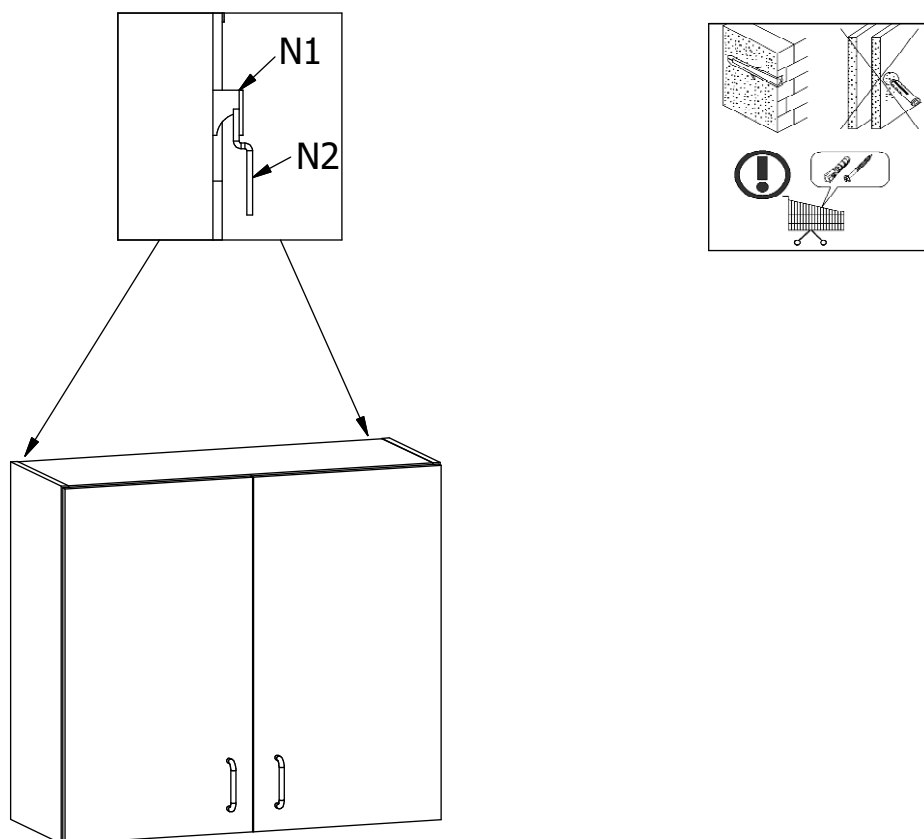

7

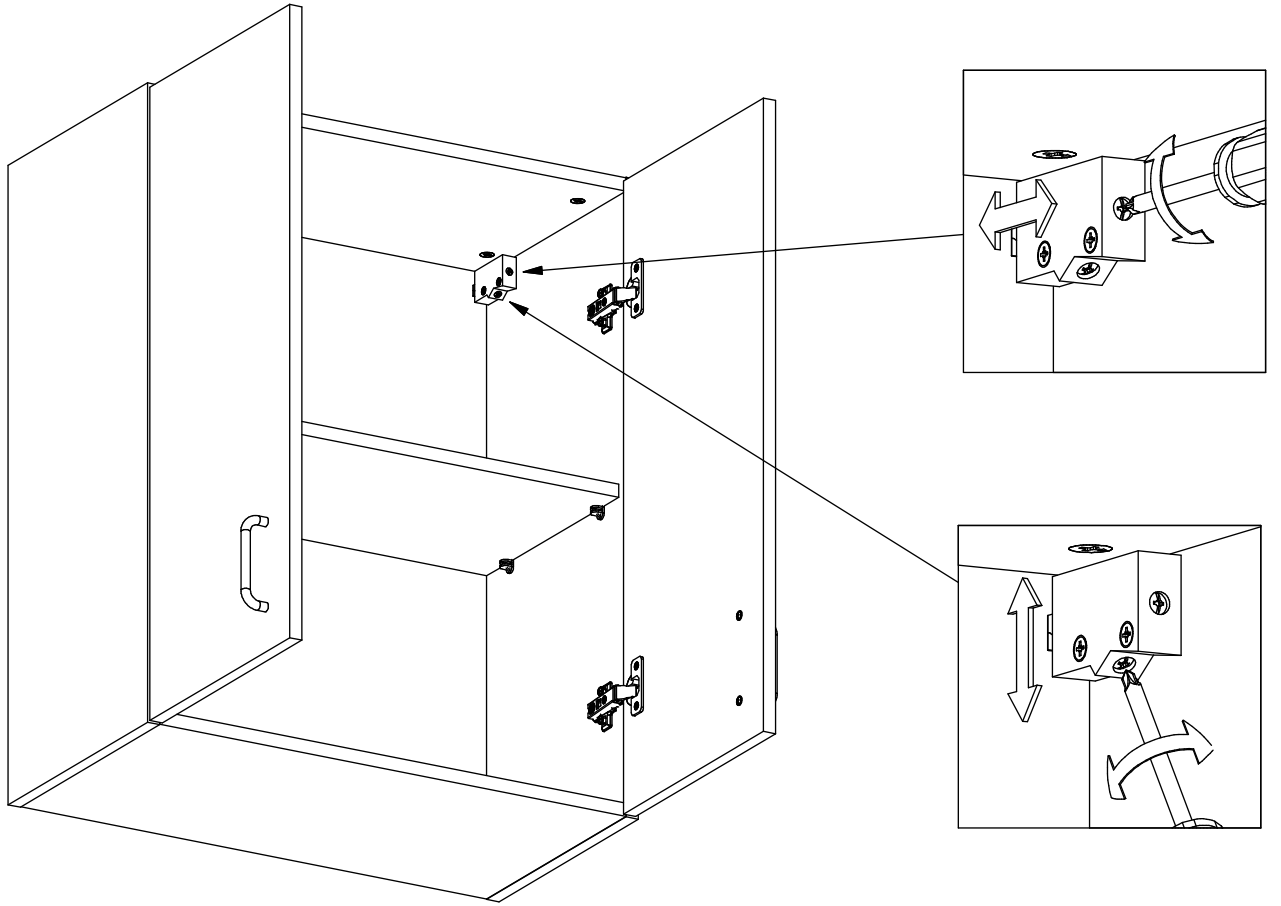

8

