

DALTON 2 NEW VE 02

UNIVERZALNY

Art.-Nr.	243987	1675	1/9
	243925	750	
	243866	1380	Z0
		mm	





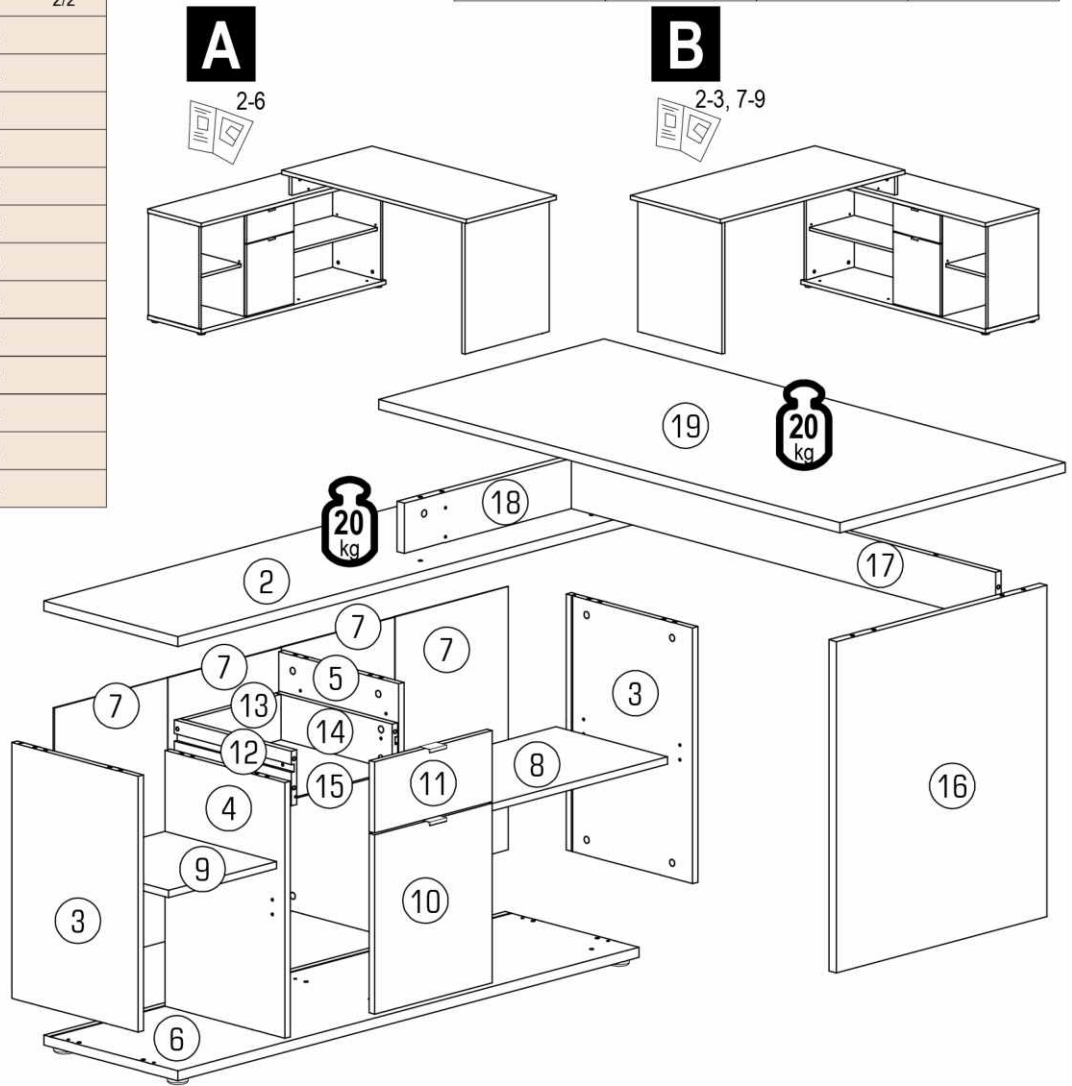





ID	ID	WxDxH	QTY	UNIT
15967	2	1380*400*22	1x	2/2
15968	3	562*378*16	2x	2/2
15969	4	562*359*16	1x	2/2
15970	5	562*359*16	1x	2/2
15971	6	1380*400*22	1x	2/2
15972	7	578*339*2,5	1x	1/2
12375	8	663*334*16	1x	1/2
12376	9	323*334*16	1x	1/2
15973	10	352*394*16	1x	1/2
15974	11	352*156*16	1x	1/2
07870	12	350*120*16	1x	1/2
15975	13	286*100*16	1x	1/2
07871	14	350*120*16	1x	1/2
15976	15	356*296*2,5	1x	1/2
15977	16	728*630*22	1x	1/2
15978	17	1270*110*16	1x	1/2
15979	18	110*630*22	1x	1/2
15980	19	1380*674*22	1x	1/2

		180 min	
PZ 2,1	4		3m







	50553,00 A 15x	22244,01 B 2x Ø3,5*16	30091,00 C 2x	27000,00 D 20x Ø8*30		E 27x	70013,01 F 31x	70021,01 G 31x	22300,00 H 6x Ø7x50	22705,00 J 4x Ø6,3x8
22502,00 K 2x M4x12	22236,00 L 8x Ø2,5x16	24008,00 M 8x 3,0	22234,00 N 4x Ø3x12	33019,00 P 1x L=310mm		Q 4x	22243,00 R 12x Ø3,5x15	35101,01 S 8x	36002,07 T 2x	36002,07 U 2x
					32240,00 V 2x	31099,00 W 2x	22250,00 X 5x Ø4x25	30080,00 Y 5x Ø44x15		Z 1x

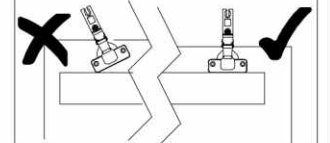
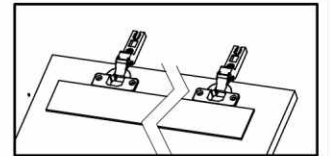
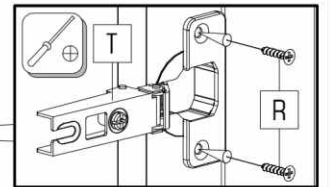
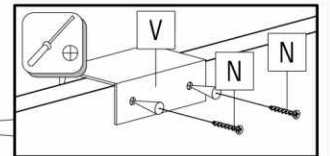
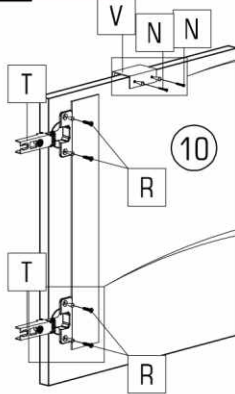
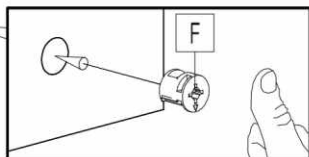
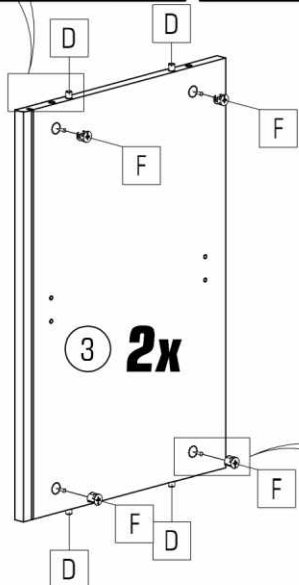
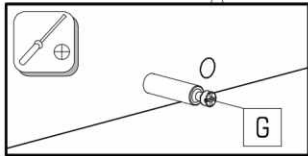
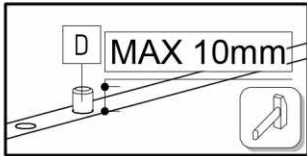
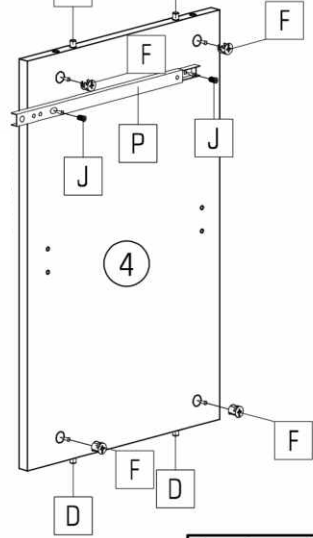
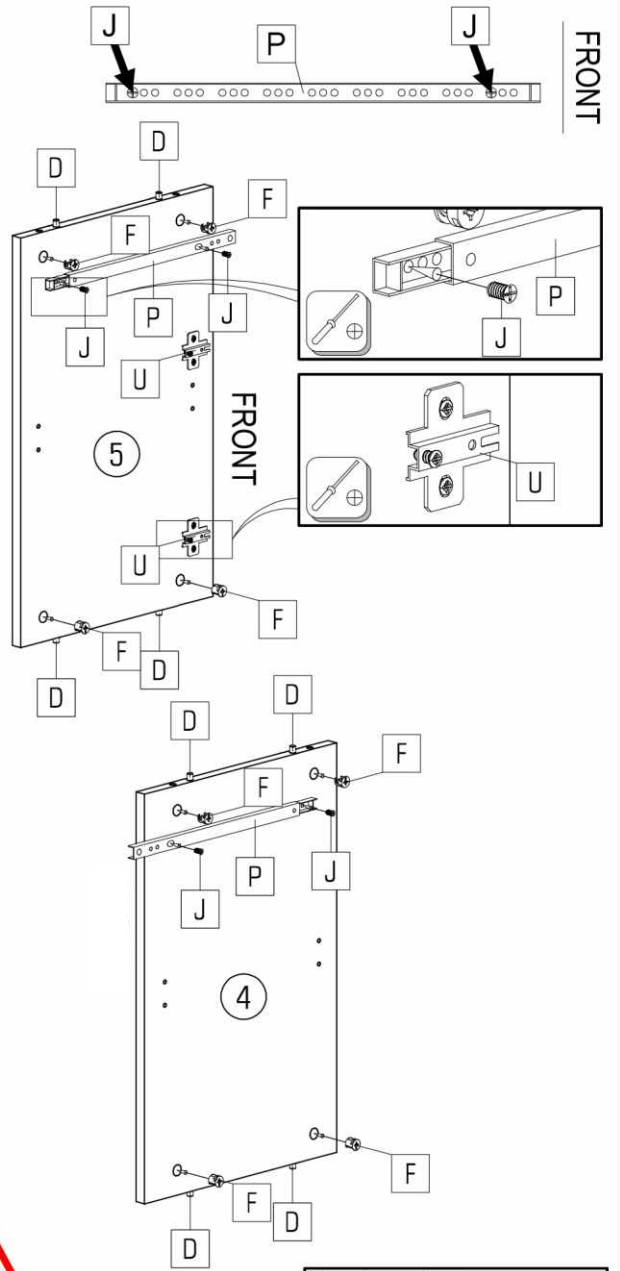
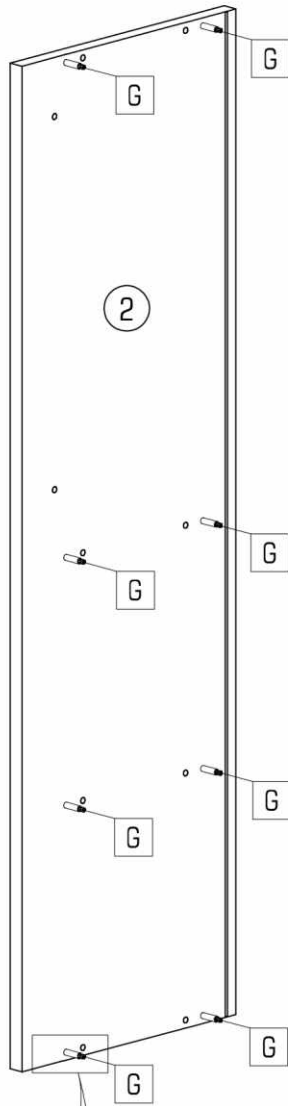
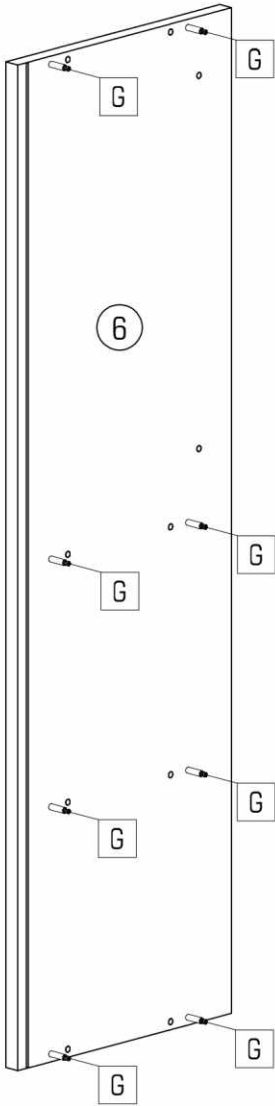



--	--	--	--	--	--	--	--	--	--

									
D 16x	F 16x	G 16x	J 4x	N 4x	P 1x	R 4x	T 2x	U 2x	V 1x

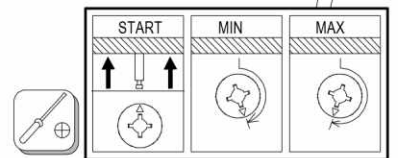
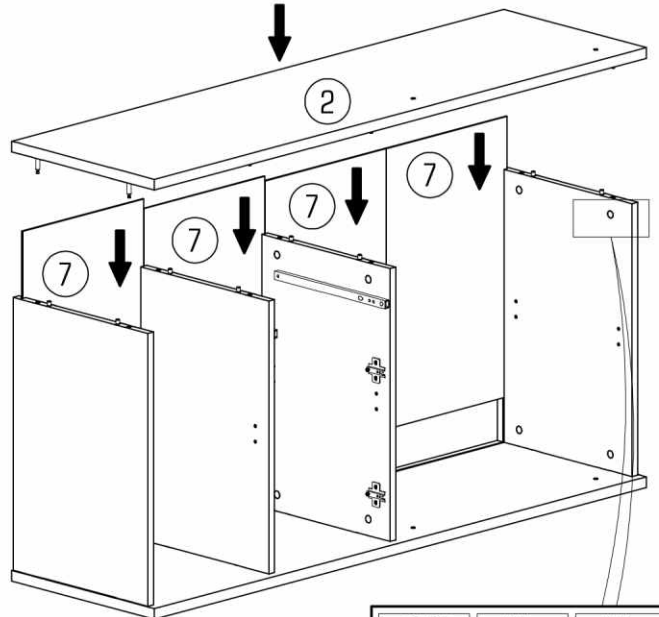
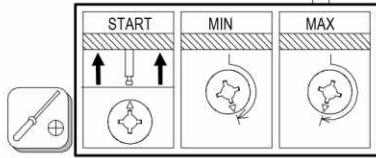
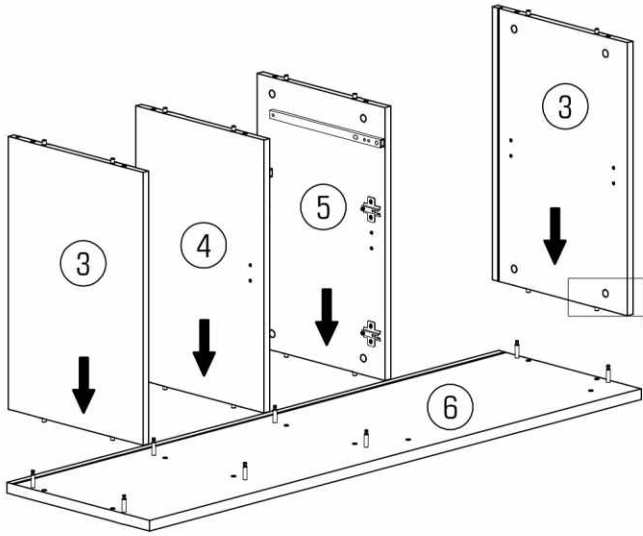
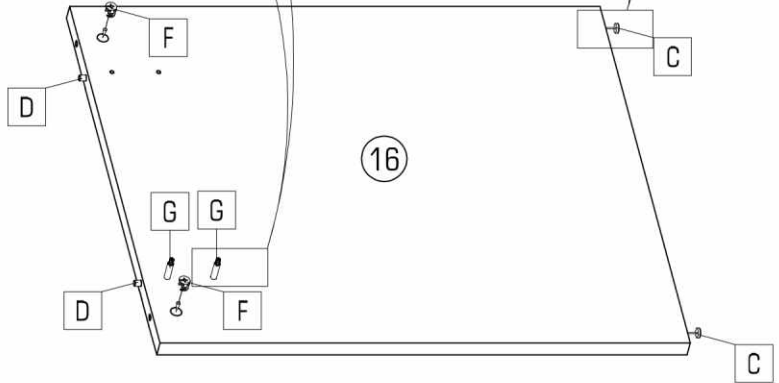
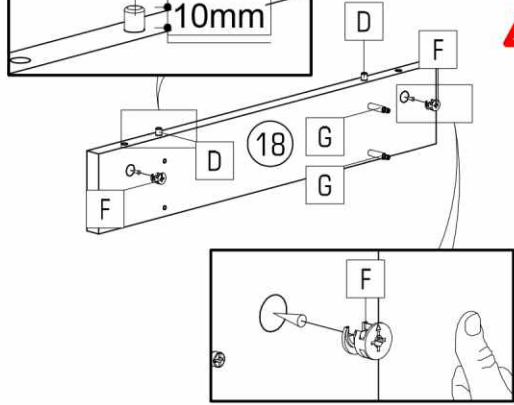
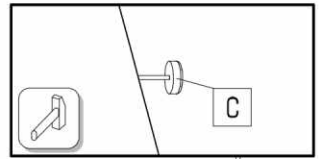
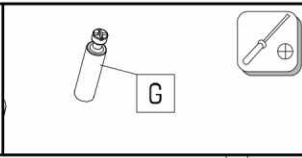
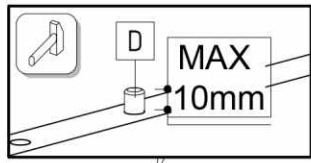



			
C	2x	D	4x
		F	4x
		G	4x



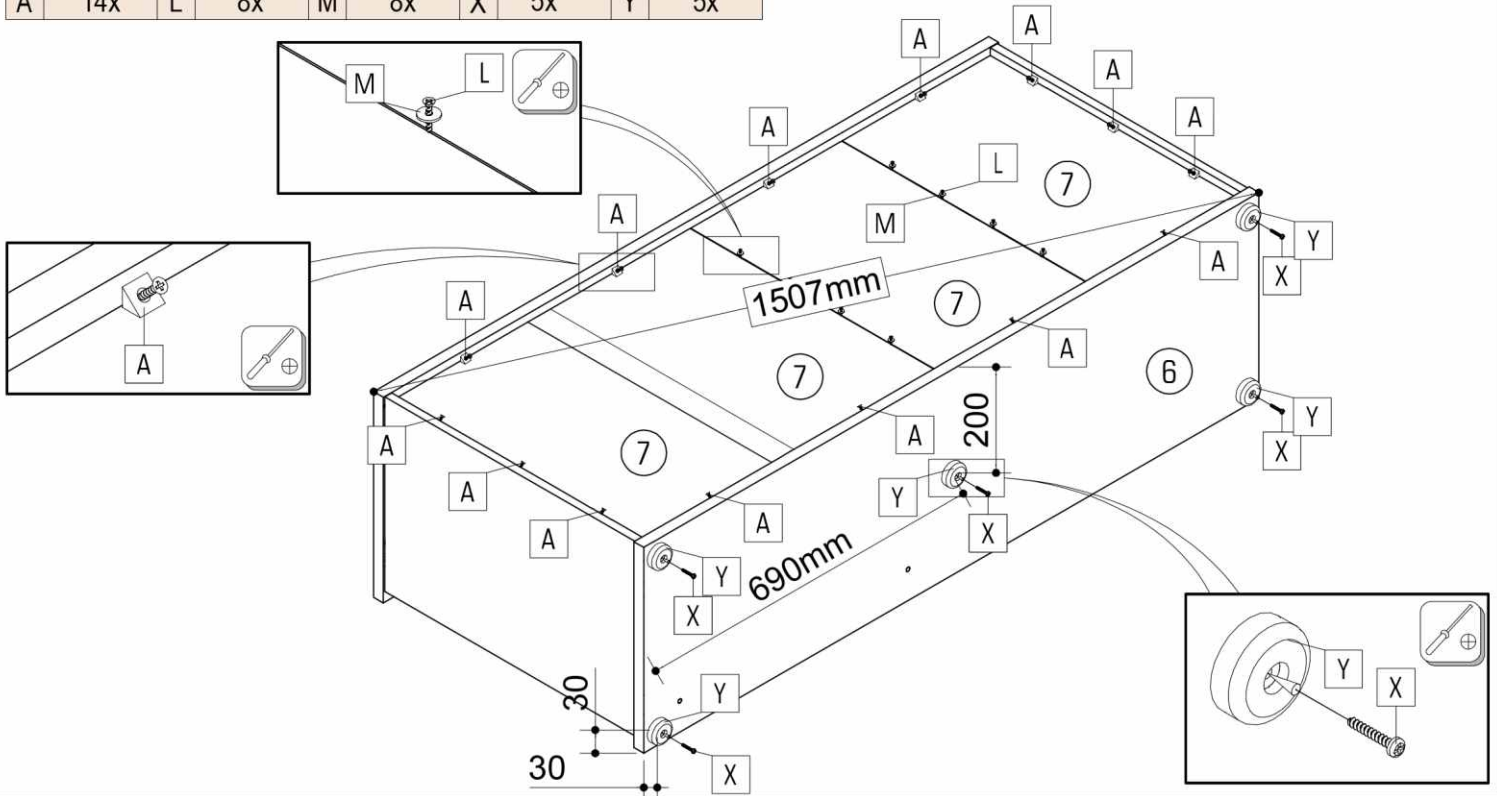

				
A 14x	L 8x	M 8x	X 5x	Y 5x



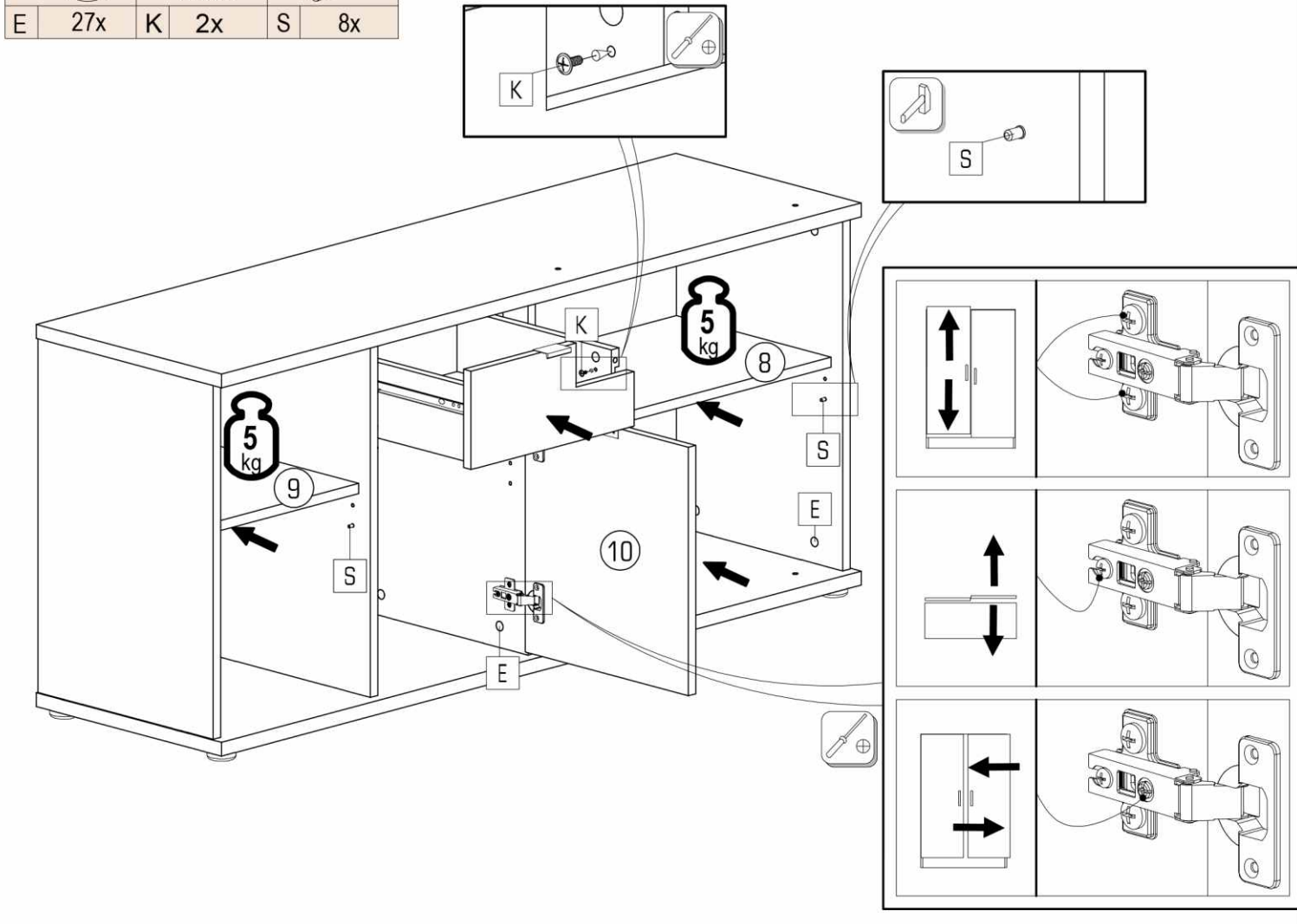

		
E 27x	K 2x	S 8x



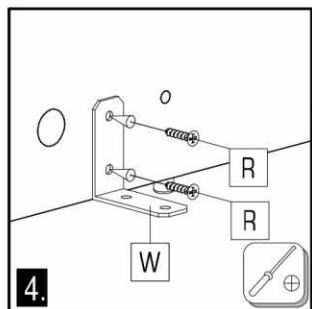
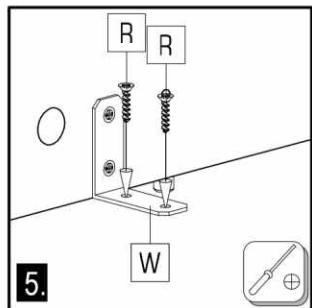
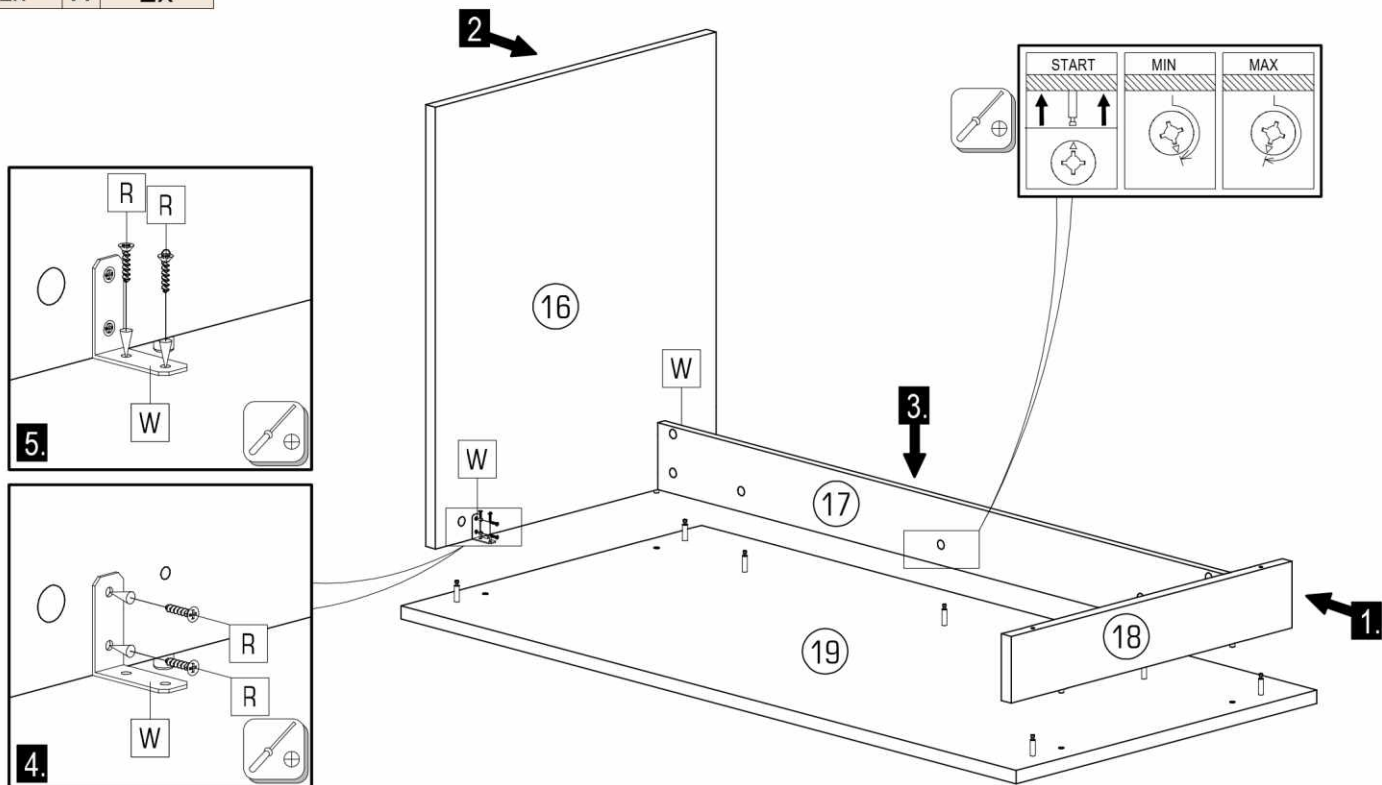



	$\varnothing 3.5 \times 15$		
R	12x	W	2x

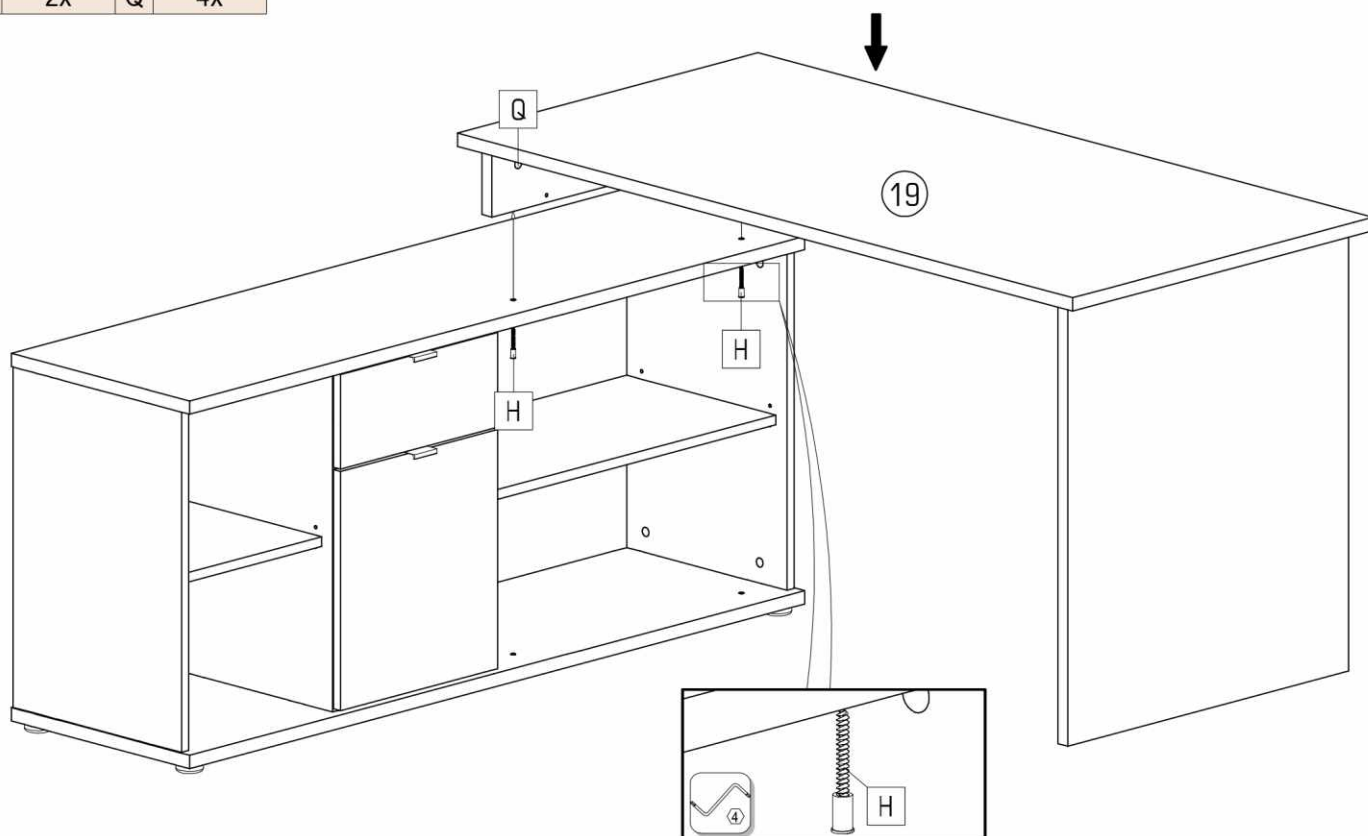





	$\varnothing 7 \times 50$		
H	2x	Q	4x

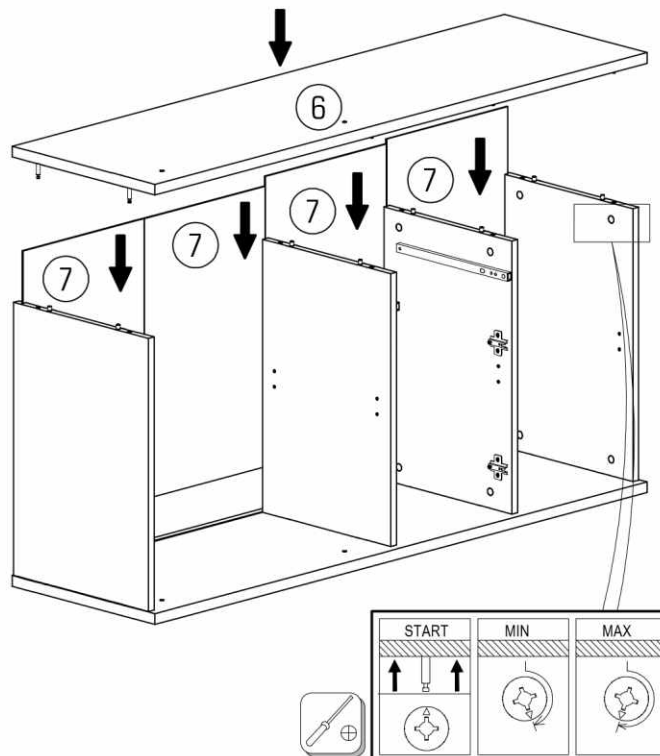
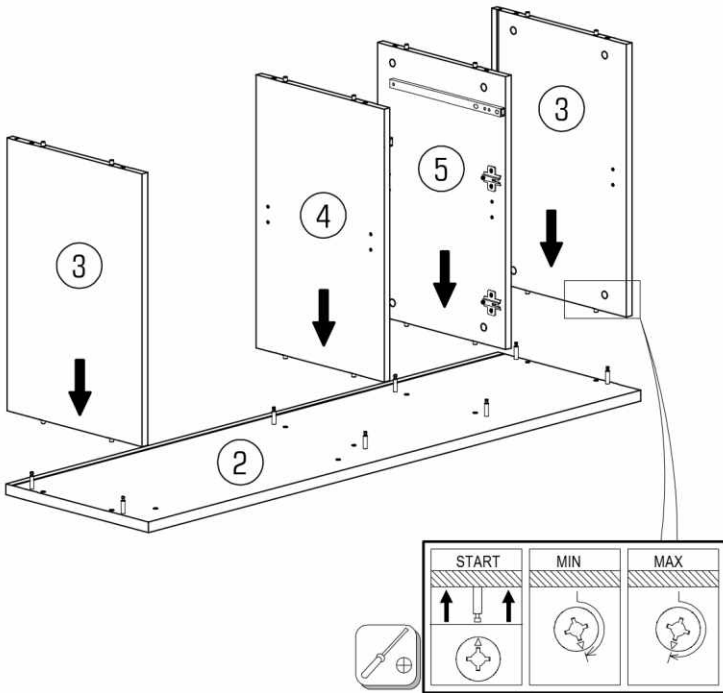
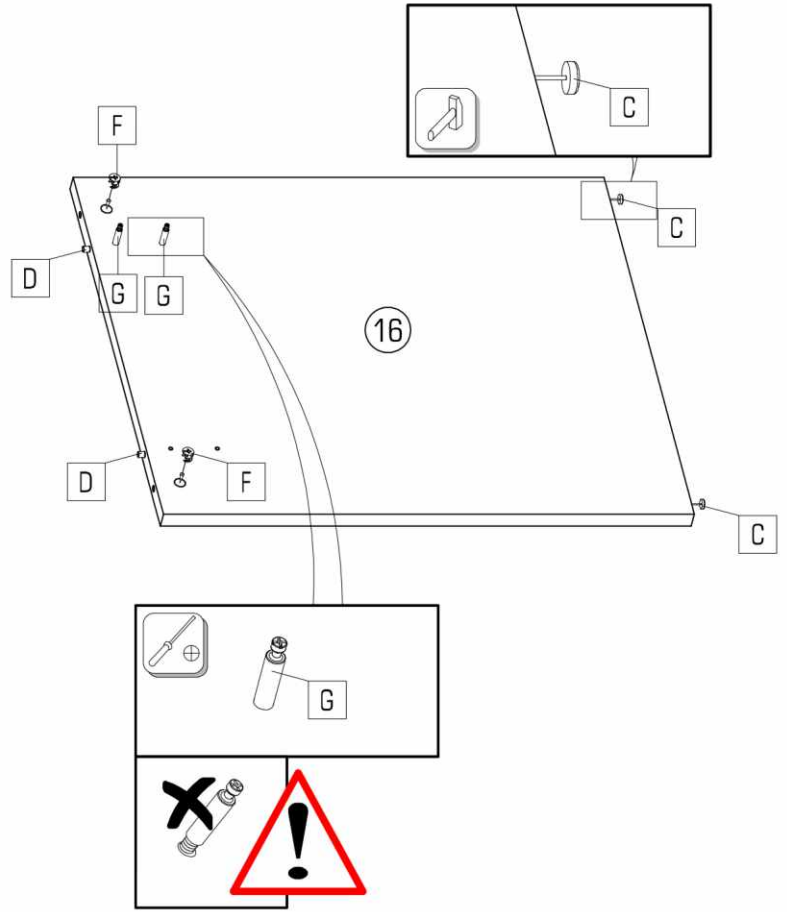
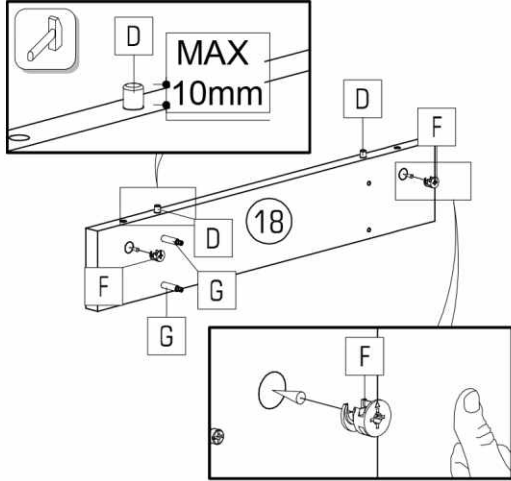



			
C	2x	D	4x
		F	4x
		G	4x



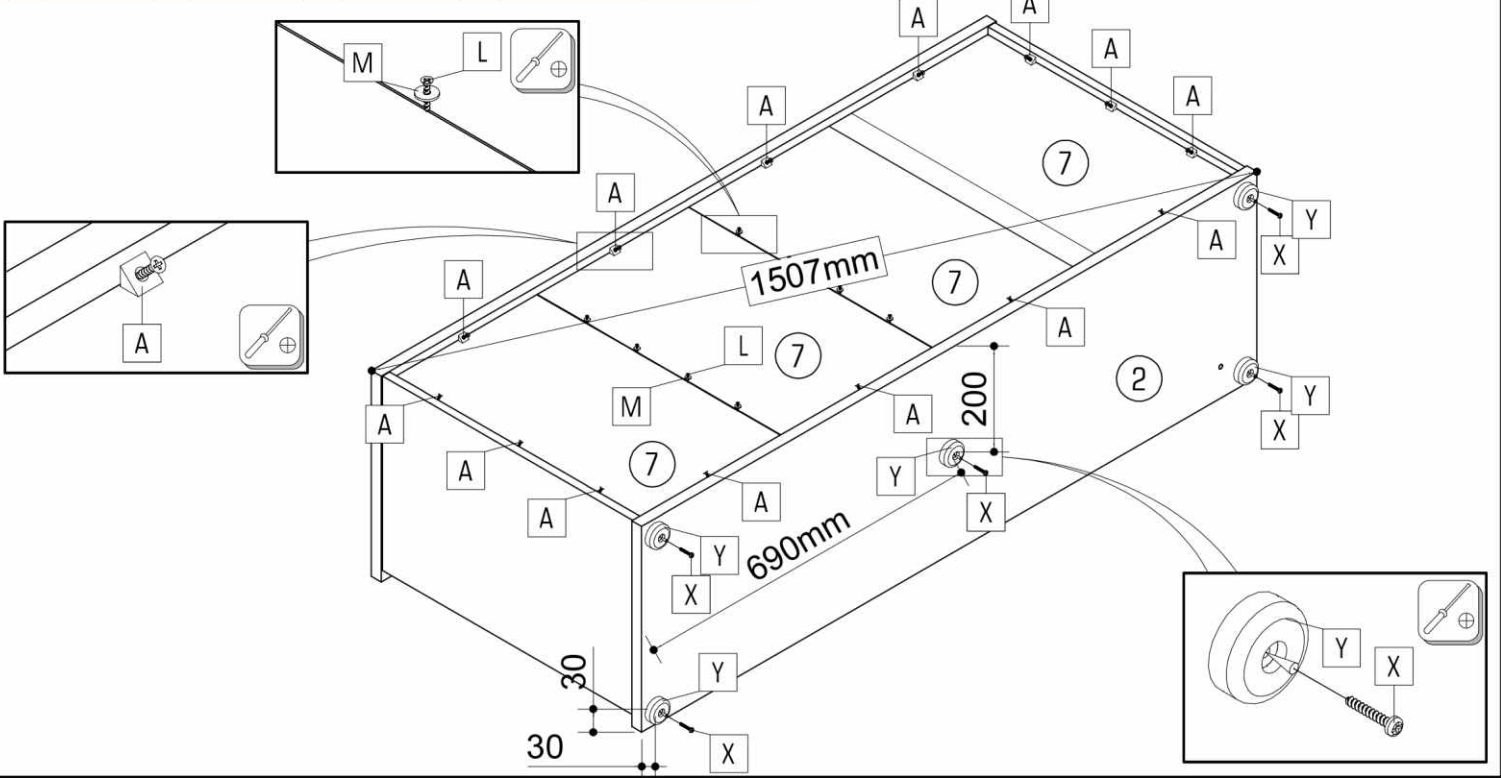

				
A 14x	L 8x	M 8x	X 5x	Y 5x



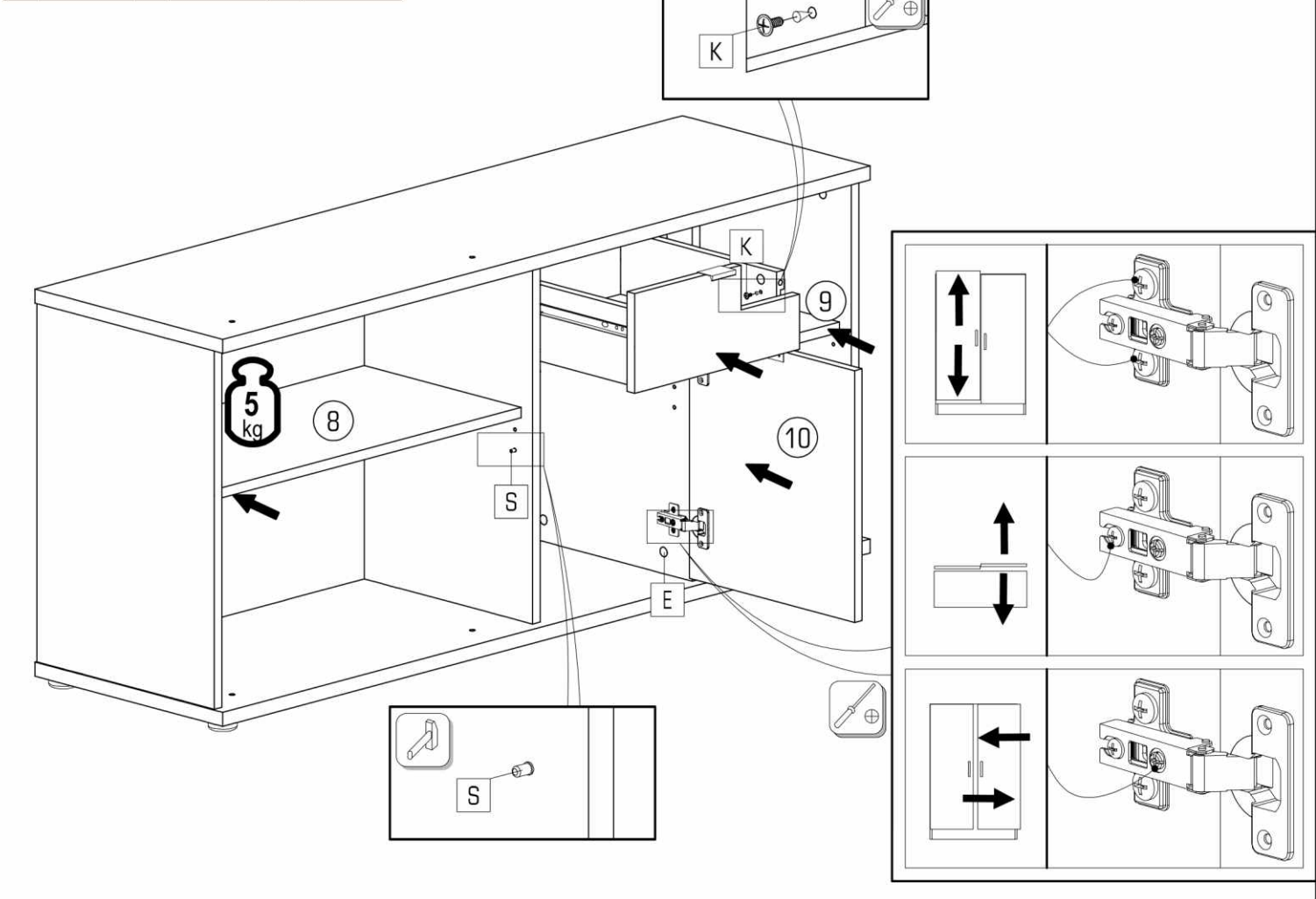

		
E 27x	K 2x	S 8x

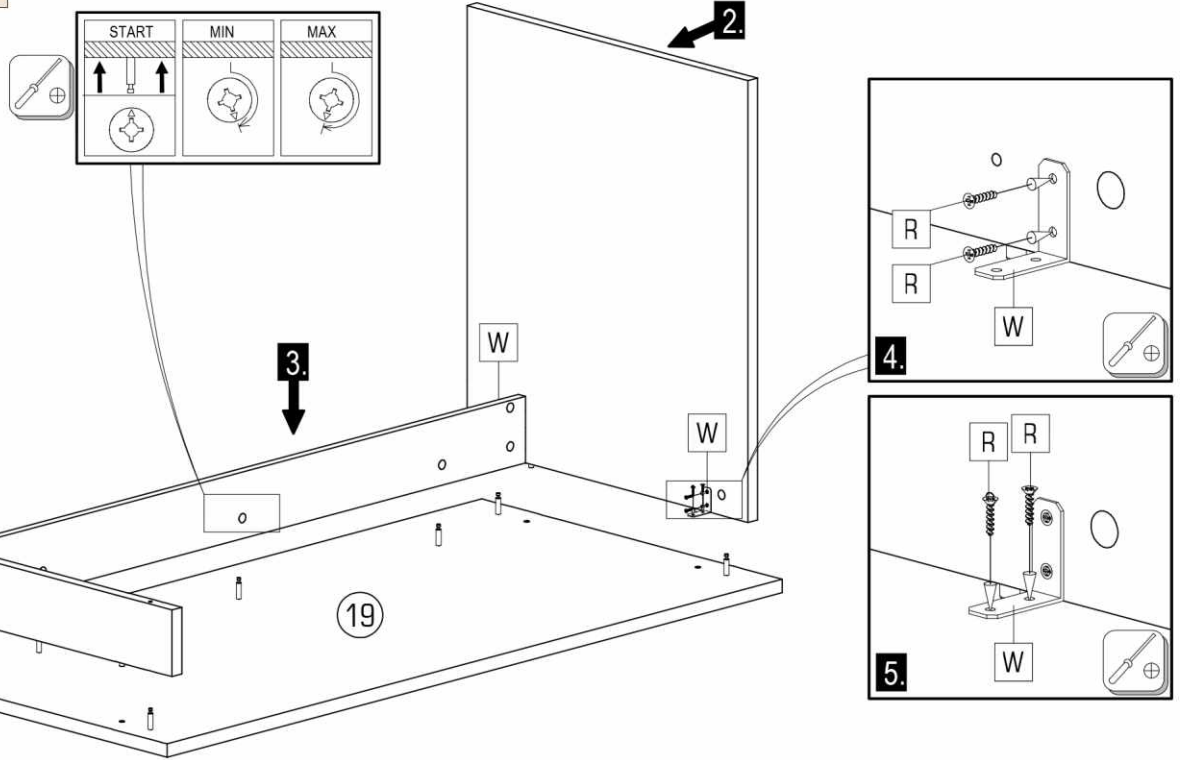

	$\varnothing 3,5 \times 15$	
R	8x	W 2x



	$\varnothing 7 \times 50$	
H	2x	Q 4x

