

SK NÁVOD NA MONTÁŽ
 CZ MONTÁŽNÍ NÁVOD
 HU SZERELÉSI UTASÍTÁS
 DE MONTAGEANLEITUNG

RIOMA TYP 22

Z0

1/6





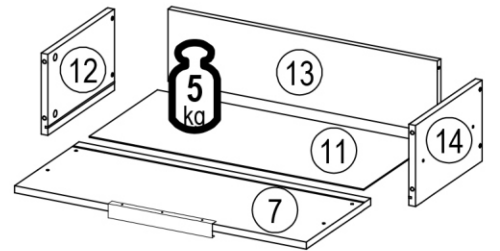
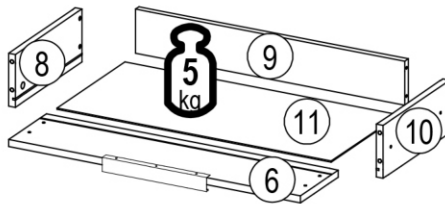
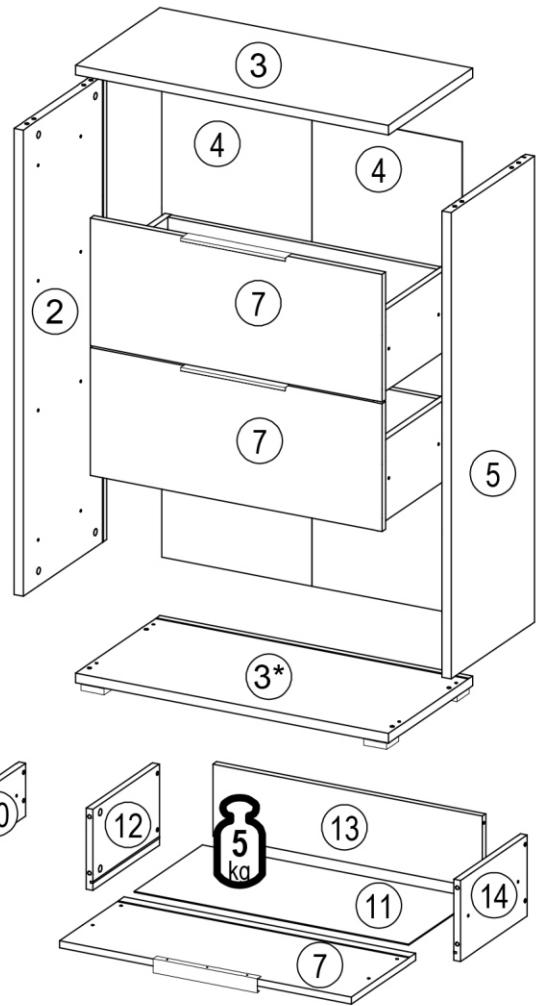
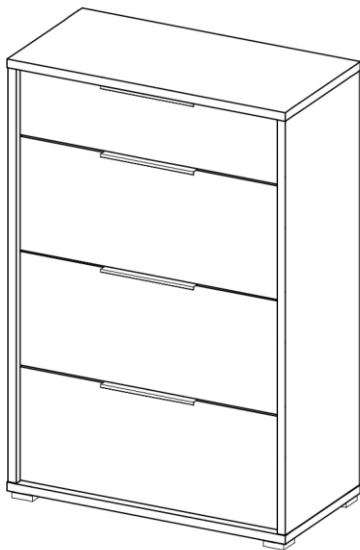

750 1122
 380 mm

100 min PZ 2 ≤ 0,5 kg 3m 4

ID	ID	Icon	Dimensions	Quantity	Unit
13607	②		1058*376*22	1x	1/2
12789	③		750*380*22	2x	1/2
12694	④		1074*360*2,5	2x	1/2
13608	⑤		1058*376*22	1x	1/2
13609	⑥		700*170*16	1x	2/2
13610	⑦		700*290*16	3x	2/2
13681	⑧		320*120*16	1x	2/2
13611	⑨		666*100*16	1x	2/2
13682	⑩		320*120*16	1x	2/2
13612	⑪		676*306*2,5	4x	1/2
13951	⑫		320*184*16	3x	1/2
13952	⑬		666*164*16	2x	1/2
13952	⑬		666*164*16	1x	2/2
13953	⑭		320*184*16	3x	1/2



22244,01 Ø3,5*16	27000,00 Ø8*30	70013,01 	70021,01 	22300,00 Ø7x50	22060,00 Ø4x30	50553,00 		30083,00 55x55x20	31103,00
A 26x	B 8x	C 24x	D 24x	E 16x	F 16x	G 24x	H 8x	J 4x	K 1x
22213,00 Ø4x70	24103,00 Ø8	22705,00 Ø6,3x8	22234,00 Ø3x12	22243,00 Ø3,5x15	33029,00 	32242,00 			
L 1x	M 1x	N 16x	P 12x	Q 24x	R 4x	S 4x	T 16x		

						
B 8x	C 8x	D 8x	F 16x	J 4x	N 16x	R 4x

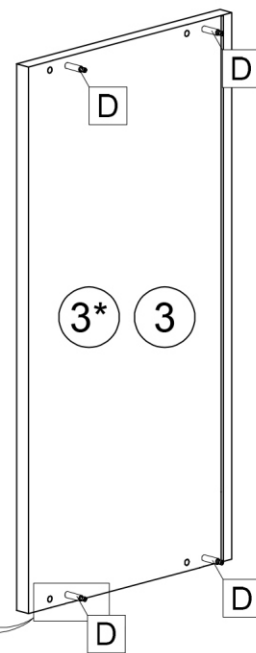
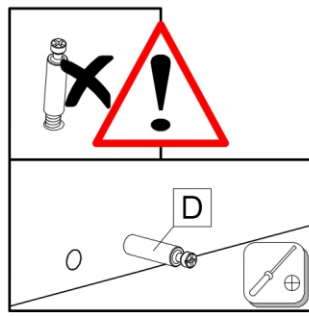
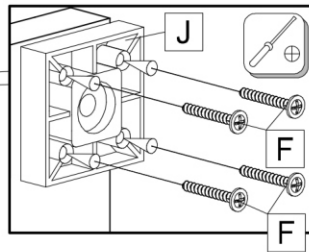
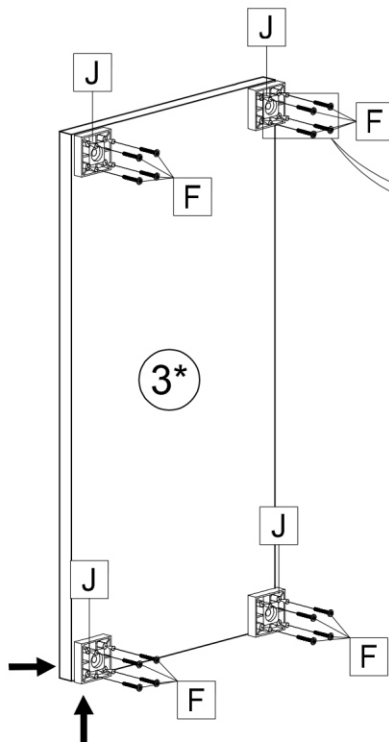
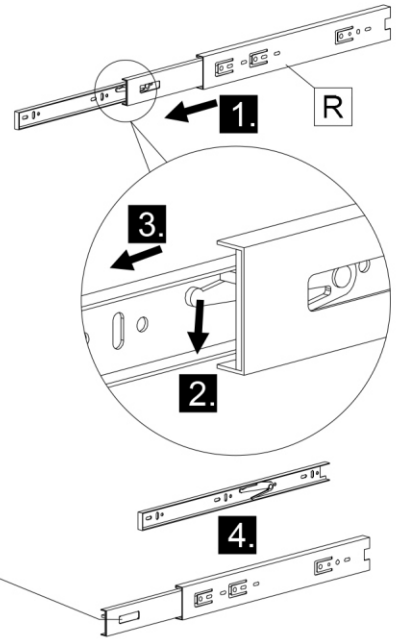
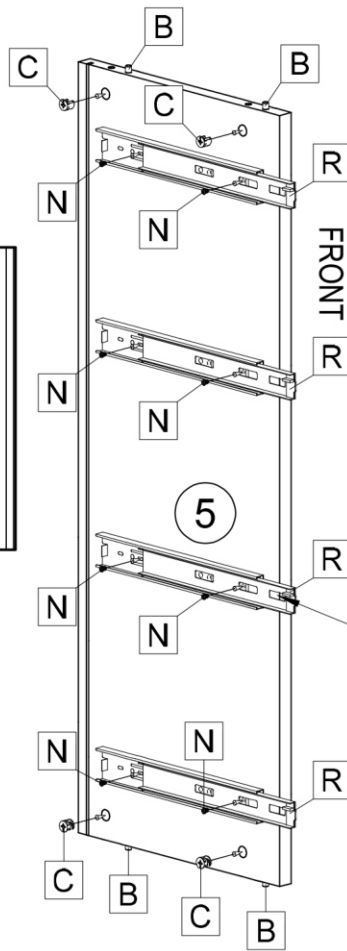
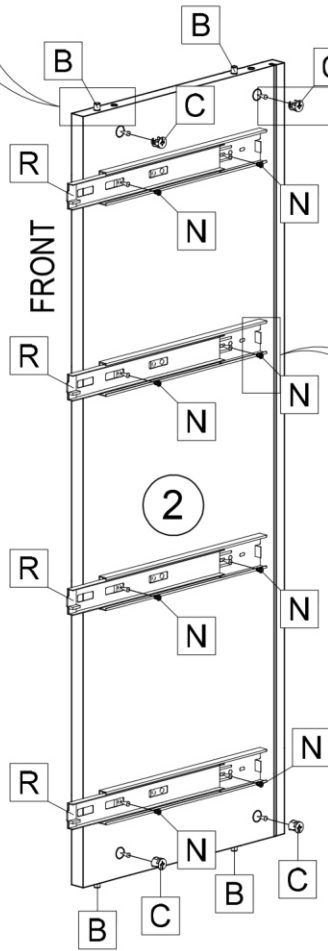
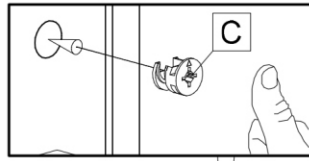
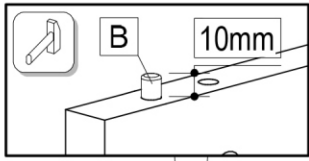

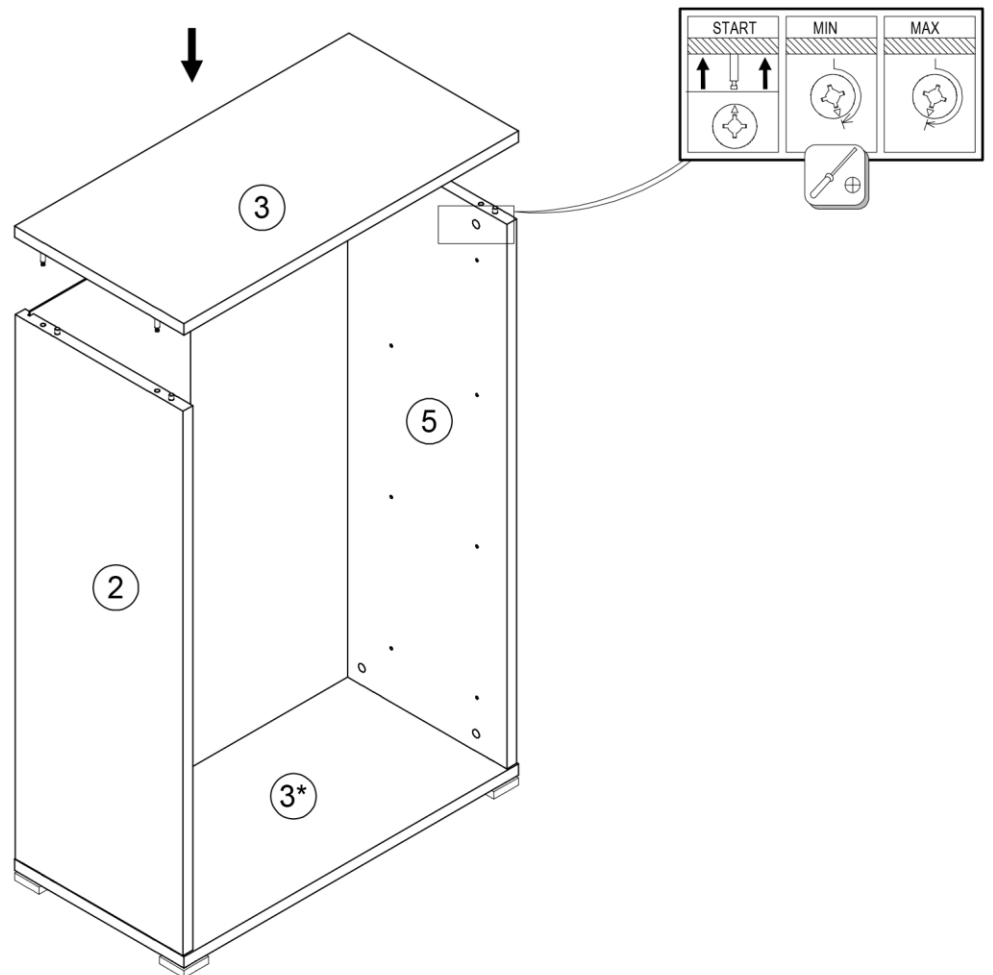
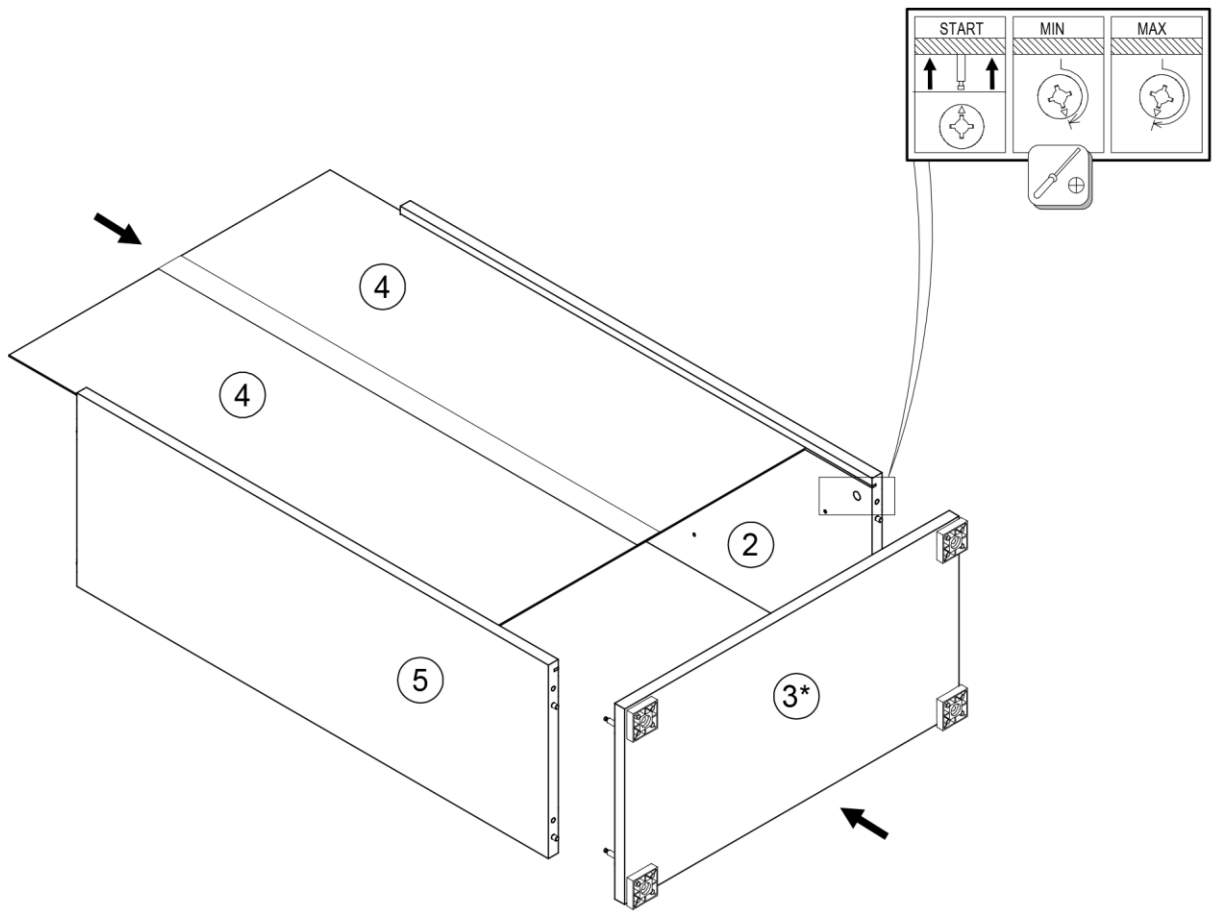

G 12x

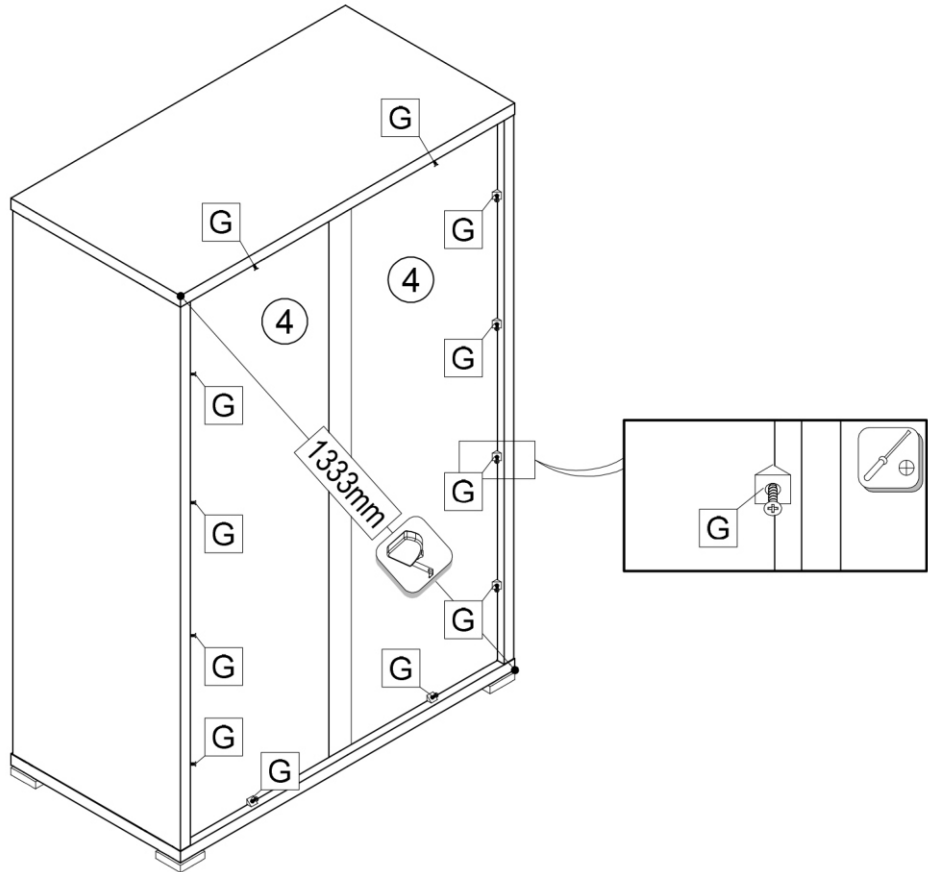





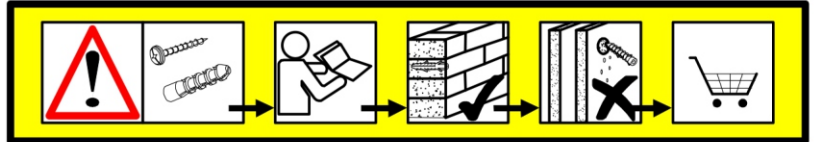
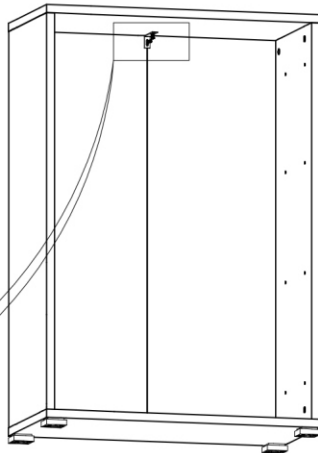

Ø3,5*16		Ø4x70	Ø8
A 2x	K 1x	L 1x	M 1x





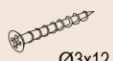

- v = 1080
- Ø8
- M
- K A
- K L

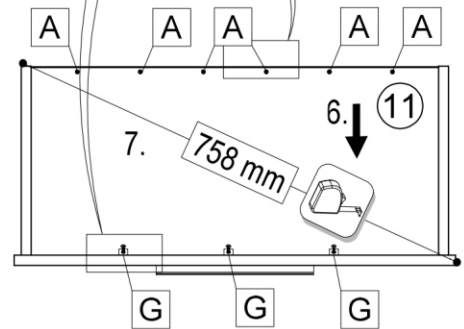
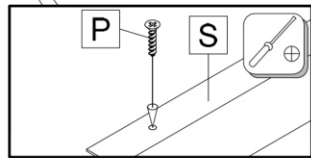
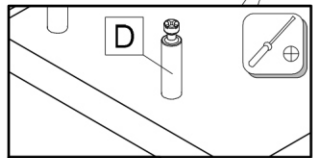
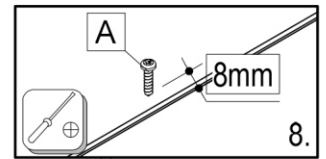
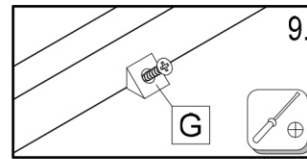
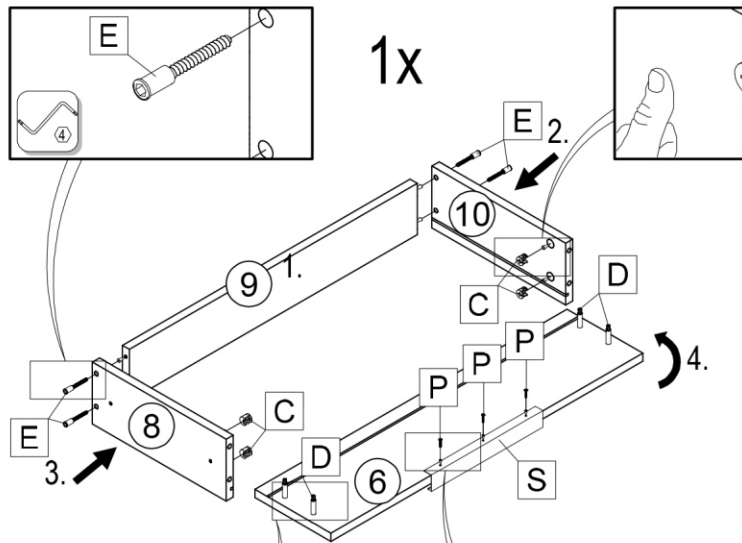
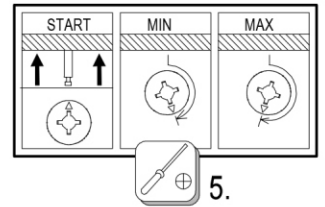





DE	Achtung! Die Wandbeschaffenheit ist vor der Montage unbedingt zu prüfen. Die beigelegten Universaldübel sind ausschließlich nur zur Verwendung für festes Mauerwerk wie Beton/Ziegel. Die Mauerdübel dürfen nicht bei Mauerwerk wie Hohlraumziegel, Leichtbausteinen, Gipskartonplatte oder anderer Rahmenbauweise verwendet werden. Bei diesen Mauerwerken sind gegebenenfalls Spezialdübel zu verwenden! Diese sind in einem Fachgeschäft (Baumarkt) erhältlich. Bei Nichterhaltung wird seitens Produzenten/Händler und Importeur keine Haftung übernommen.	EN	Caution! The wall must be examined before assembly. The included universal wall plugs are only suitable for using in firm masonry such as concrete block or brick. Do not using the wall plugs masonry such as hollow brick, lightweight block, surfaces such as gypsum plasterboard or other framing systems. If applicable, particular wall plugs must be used! These are available at a specialised store (hardware store). In case of non-compliance, the manufacturer/retailer or importer do not assume liability.
SLO	Pozor! Pred montažo preverite stanje stene. Priloženi univerzalni mozniki so izključno samo za uporabo na čvrstem zidovju, kot sta beton in opeka. Stenski mozniki se ne smejo uporabljati pri zidovju kot so votlina opeke, zidaki za lahko gradnjo, mavčne plošče ali druge okvirne gradnje. Pri teh zidovjih morate v danih primerih uporabljati posebne moznike. Ti so na voljo v specializiranih trgovinah (trgovinah z gradbenim materialom). Pri upoštevanju se s strani proizvajalca/trgovca in uvoznika ne prevzame jamstvo.	HR	Pažnja! Prije montaže obavezno provjerite svojstvo zida. Priložene univerzalne tiple namijenjene su isključivo za masivne zidove od betona/opeke. Tiple za masivne zidove ne smiju se koristiti za zidove kao npr šupljina opeka laki sastavni elementi, gips-kartonske ploče ili drugi modularni načini gradnje. Za te zidove potrebne su eventualno specijalne tiple! Iste su dostupne u specializiranim trgovinama građevniškim materijalom. U slučaju neprilježavanja prethodno navedenih napomena, proizvođač/trgovac i uvoznik ne preuzimaju odgovornost!
SK	Upozornenie! Pevnosť steny sa musí pred montážou bezpodmienečne skontrolovať. Univerzálne hmoždenky, ktoré sú obšíahnuté v balení, používajte jedine pre pevné murivo ako je betón/tehla. Hmoždenky sa nesmú používať v prípade ľahkého stavebného muriva, dutina tehla, u sádrokartónových dosiek alebo iných konštrukcii rámu. U týchto murív je nutné použiť špeciálne hmoždenky! Tieto je možné dostať v špeciálnych predajniach so stavebným materiálom (stavebniny). Pri nedodržaní pokynov nepreberajú výrobcovia/predajca a dodávateľa zodpovednosť za vzniknuté škody.	CZ	Upozornění! Před montáží je nutné zkontrolovat stav stěny. Přiložené univerzální hmoždinky jsou určeny pouze k použití pro pevné zdivo jako beton/cihly. Hmoždinky do zdi se nesmí používat u dutinová cihla, zdiva jako pórovitý stavební kámen, sádrokartonová deska nebo jiný měkký materiál. U těchto zdív jsou nutné použít speciální hmoždinky! Jsou k dostání v speciálních prodejnách se stavebním materiálem. Při nedodržení těchto pokynů výrobce/prodejce a dovezce neuzná za způsobené škody.
HU	Vigyázat! Szorosan ellenőrizni a falállékellet feltételét vizsgálni meg. A mellékelt univerzális tölpi kizárólag stabil falazathoz használható mint például beton/tégla. A fal tölpi nem használható könnyű építőkövekhez, üreg tégla, gipszkarton lapokhoz vagy más falfazás építményekhez. Ezekhez a falállékelhez csak speciális tölpi használhatóak, melyek szaküzletekben (Baukauf- / Baumärkten) beszerezhetők. Fenntek figyelmen kívül hagyása esetén a gyártó/kereskedő vagy forgalmazó nem vállal felelősséget.	S	OBS! Väggens sammansättning ska absolut kontrolleras innan monteringen. De bifogade pluggarna får endast användas för stabila och fasta väggar, som t.ex. betong/tegel. De får absolut inte användas för kavitet tegel, väggar av fonolit, gipskivor eller dylikt. För dessa väggar måste det användas speciella pluggar, som finns att köpa i specialiserad handel (Byggnads). Varken tillverkare, handlare eller importör övertar ansvar, om dessa anvisningar inte följs.

						
A 6x	C 4x	D 4x	E 4x	G 3x	P 3x	S 1x

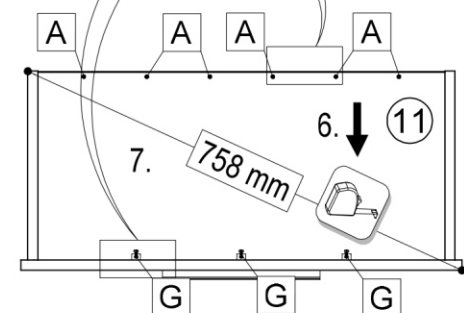
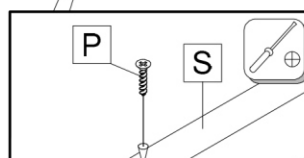
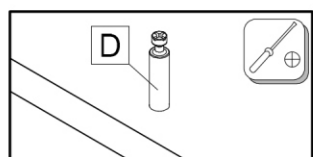
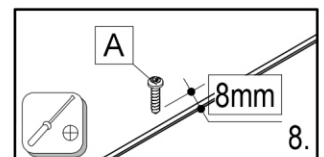
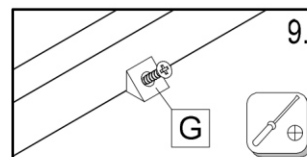
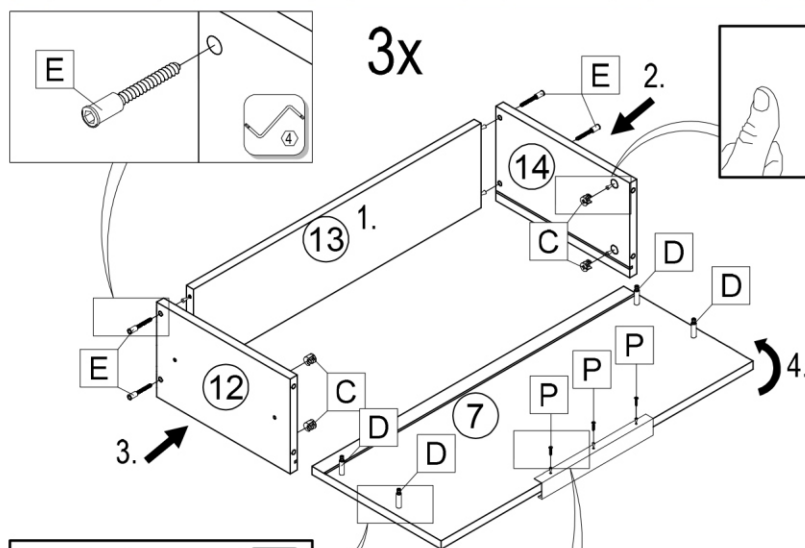
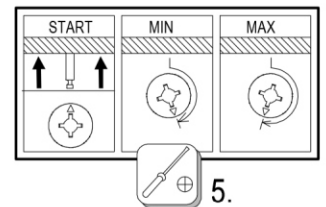

						
A 18x	C 12x	D 12x	E 12x	G 9x	P 9x	S 3x

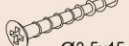

			
H 8x	Q 24x Ø3,5x15	R 4x	T 16x

