

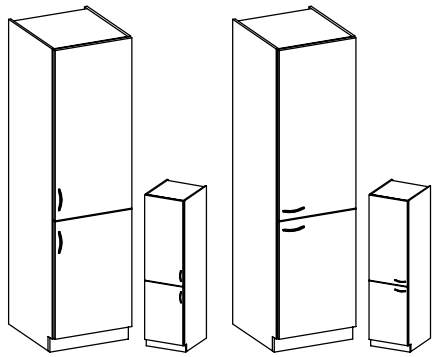











40 DK-210 2F

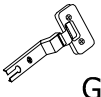
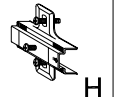

 B 12	 E1 12	 A 12	 O 1	 S23 2	M4.0x22mm  U 4	L3.0x20mm  P7 10-15
 J 16	 G 5	 H 5	L3.5x13mm  P5 12	 F2 4		
L4.0x45mm  P4 2	 E9 2	 L19 1				

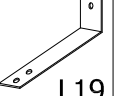
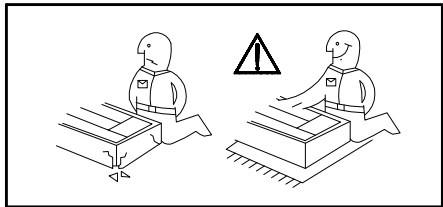
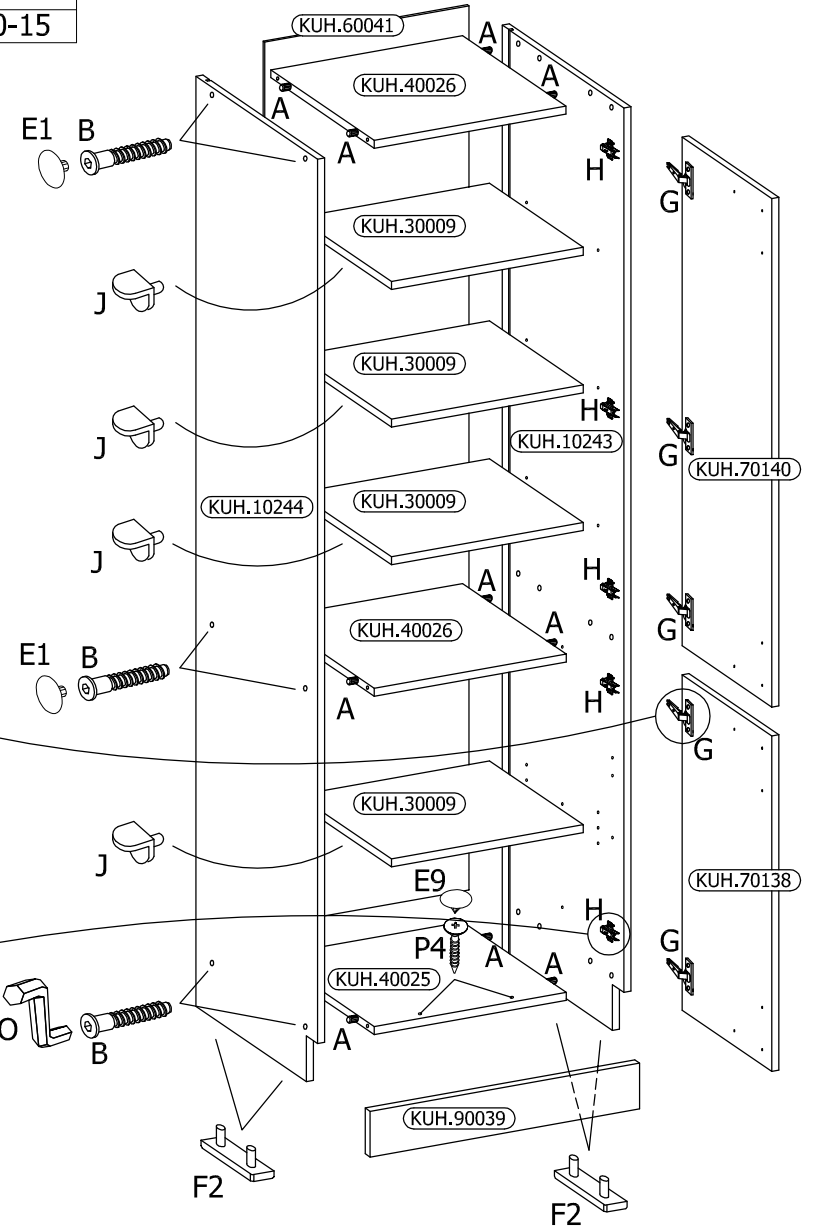
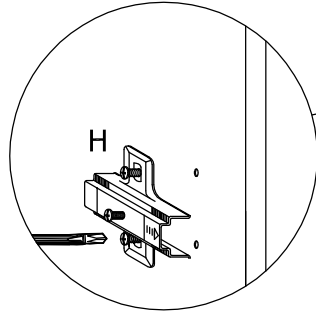
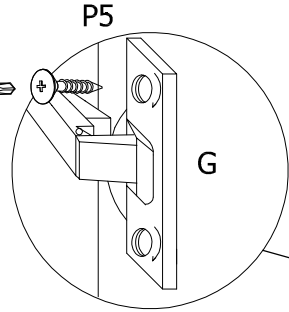
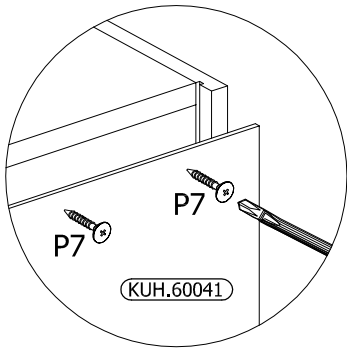
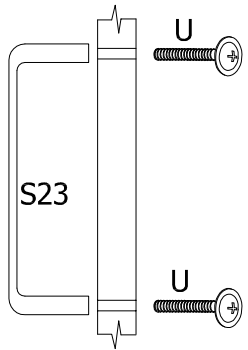
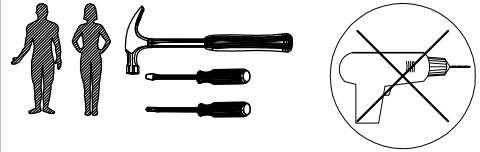

40 DK-210 2F

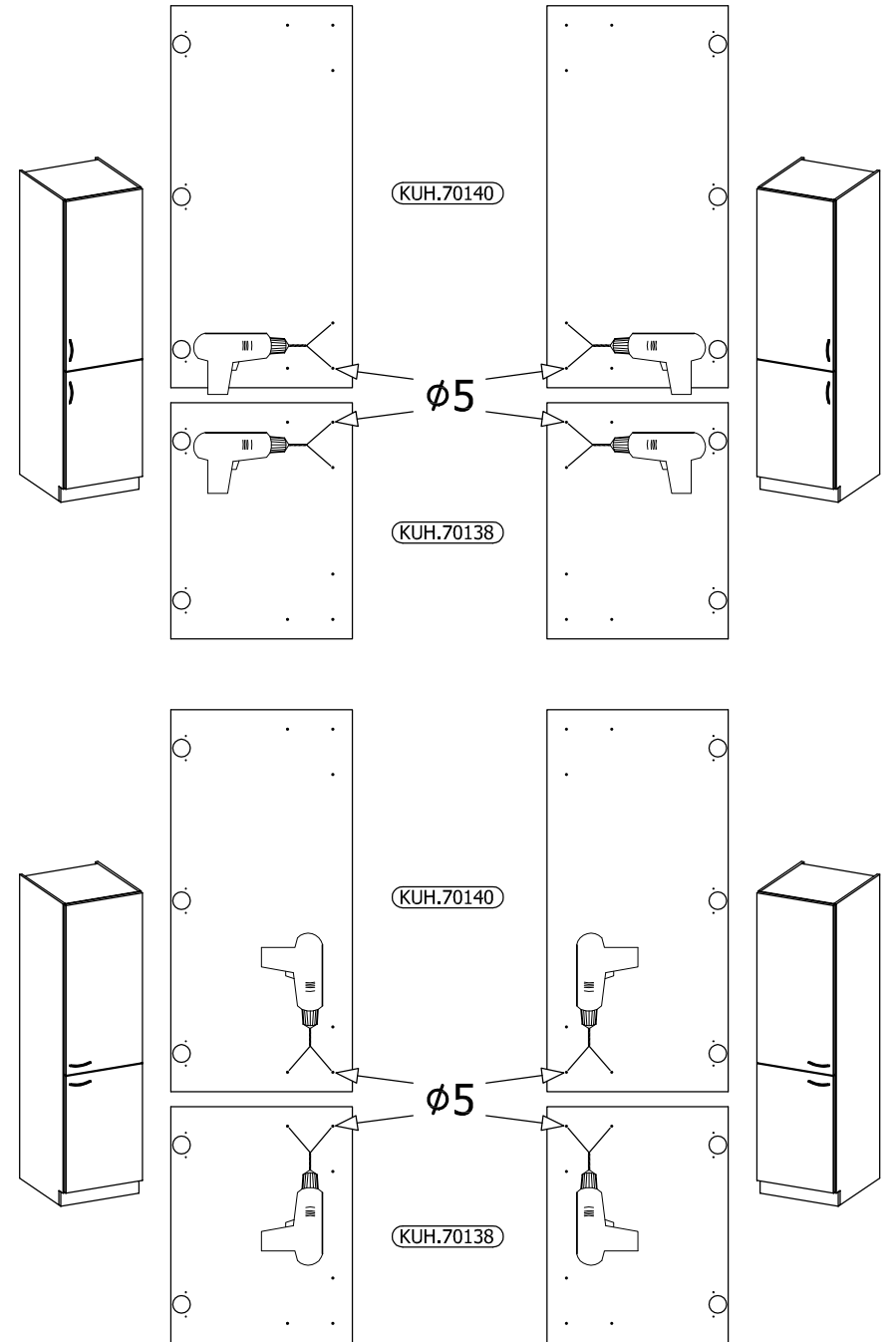
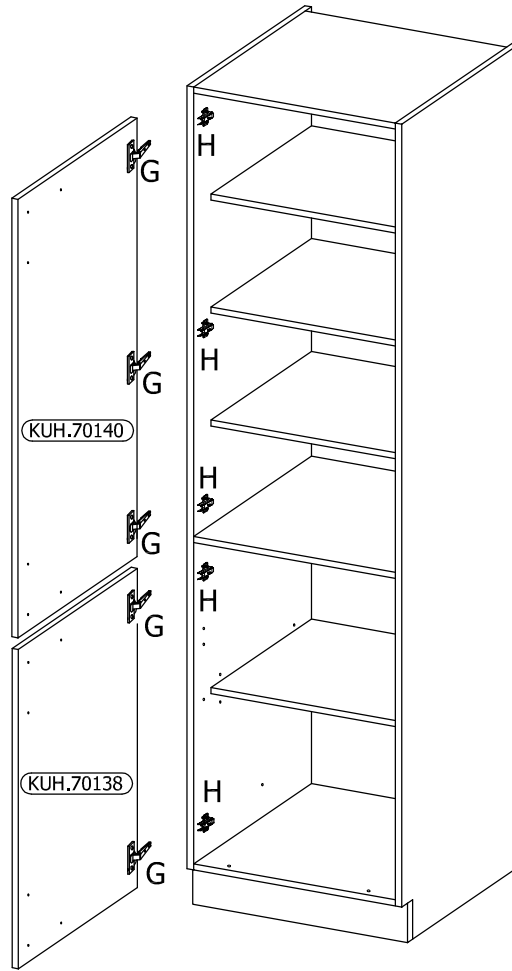
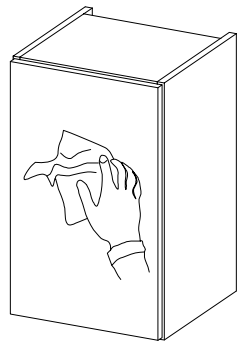
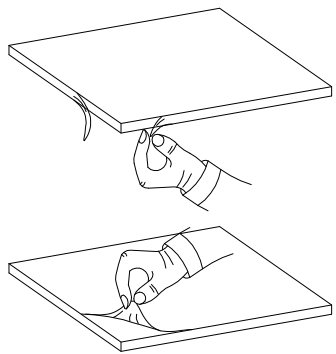
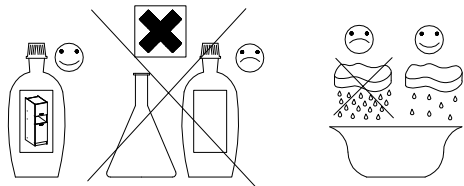
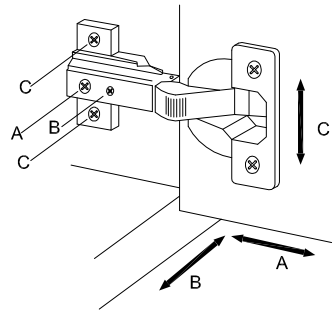
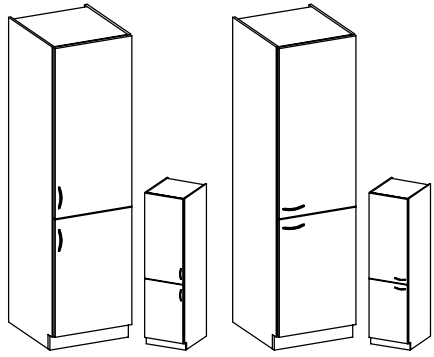

40 DK-210 2F

